

Lectures 17

NPTEL Course

GROUND IMPROVEMENT

GROUND TREATMENT WITH LIME

Prof. G L Sivakumar Babu
Department of Civil Engineering
Indian Institute of Science
Bangalore 560012
Email: glc@civil.iisc.ernet.in

**Lime treatment can be used to improve soft soils
and expansive soils**

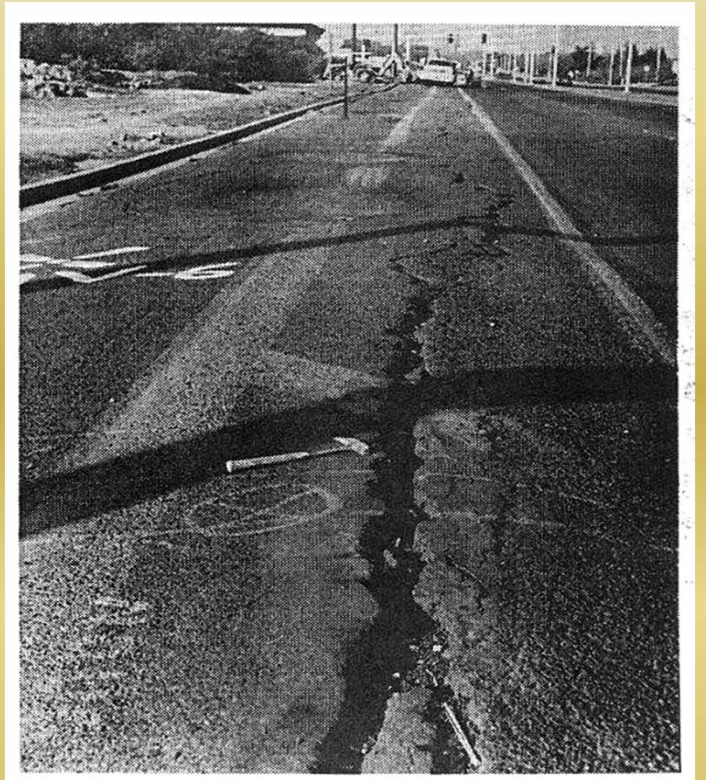

Problems with expansive soils



Source: <http://www.geoengineer.org>



Source:
http://www.pavementinteractive.org/index.php?title=Image:Subgrade_crack.JPG

Pavement Cracking in swelling ground

Premature Failures in soil after treatment



- **Introduction**
- **Description of method**
- **Applications**
- **Mechanism of stabilization**
- **Shear strength improvements**
- **Settlements Improvement**
- **Foundation Design**
- **Case studies**
- **Quality control measures**
- **Conclusions**

INTRODUCTION

- Stabilization using lime is an established practice to improve the characteristics of fine grained soils.
- The first field applications in the construction of highways and airfields pavements were reported in 1950-60. With the proven success of these attempts, the technique was extended as for large scale soil treatment using lime for stabilization of subgrades as well as improvement of bearing capacity of foundations in the form of lime columns

Mechanism of stabilization

The addition of lime affects the shear strength, compressibility, and the permeability of soft clays. These beneficial changes occur due to the diffusion of lime.

Soil-lime reaction

- Cation-exchange
- Flocculation
- Aggregation (time and temperature dependent.)

1(a) Cation Exchange

- It is an important reaction and mainly responsible for the changes occurring in the plasticity characteristics of soil.
- The cation replacement takes place in order of their replacing power



- CEC highly depends on the pH of the soil water and the type of clay mineral in the soil.

Montmorillonite (highest); Koalinite (Lowest).

➤ Ca(OH)_2 [formed either due to hydration of quicklime or when it is used directly] dissociates in the water.

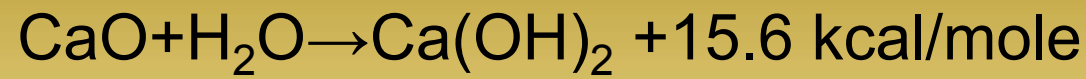

➤ It increases the electrolytic concentration and p_{H} of the pore water and dissolves the silicates (SiO_2) and aluminates (Al_2O_3) from the clay particles.

➤ Na^+ and other cations adsorbed to the clay mineral surfaces are exchanged with Ca^{++} ions.

1(b) Flocculation

Untreated clays have a molecular structure similar to some polymers, and give plastic properties. The structure can trap water between its molecular layers, causing volume and density changes.

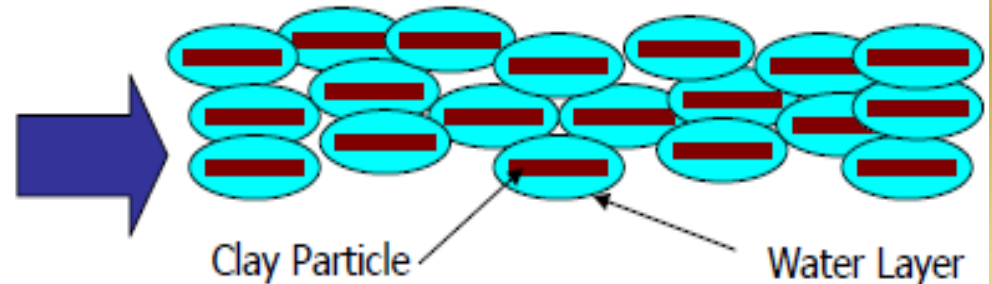

Flocculation/Agglomeration

In treated clays Calcium and Magnesium atoms (from Lime) have replaced Sodium and Hydrogen atoms producing a soil with very friable characteristics

1(c) Pozzolanic

Literature review reveals that the addition of lime to soil alters the properties of soil and this is mainly due to the formation of various compounds such as calcium silicate hydrate (CSH) and calcium aluminate hydrate (CAH) and micro fabric changes(Pozzolanic reaction).

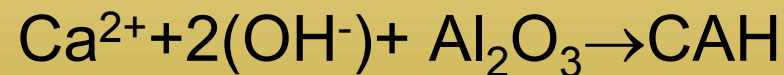
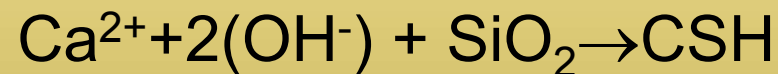

The reaction is much slower reaction than the hydration of cement and hence some times cement is added to increase the rate of reaction.

Pozzolanic Reactions Using Lime (Clay Soil)

On-going reaction with available silica and alumina in the soil forms complex cementitious materials (the POZZOLANIC effect.)

Add lime and fly ash to stabilize soil low in clay.

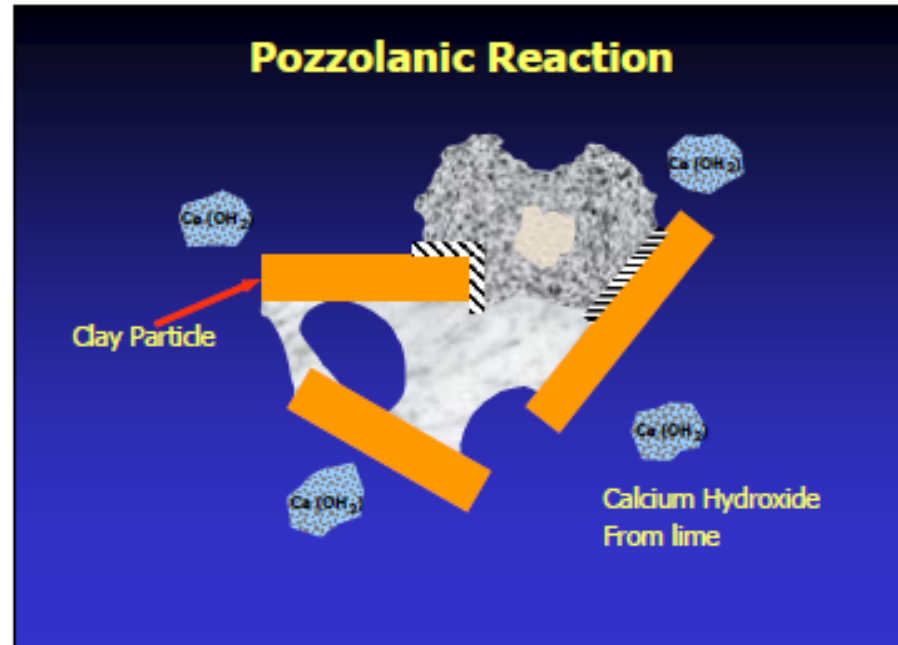

Factors controlling the characteristics of lime treated clay

- Type of lime (Quick lime or Hydrated lime)
- Lime content
(Lime Fixation Point and Optimum lime content)
- Curing time
- Type of soil
- Clay mineral
- Soil pH
- Curing temperature

Variation of index properties with addition of lime

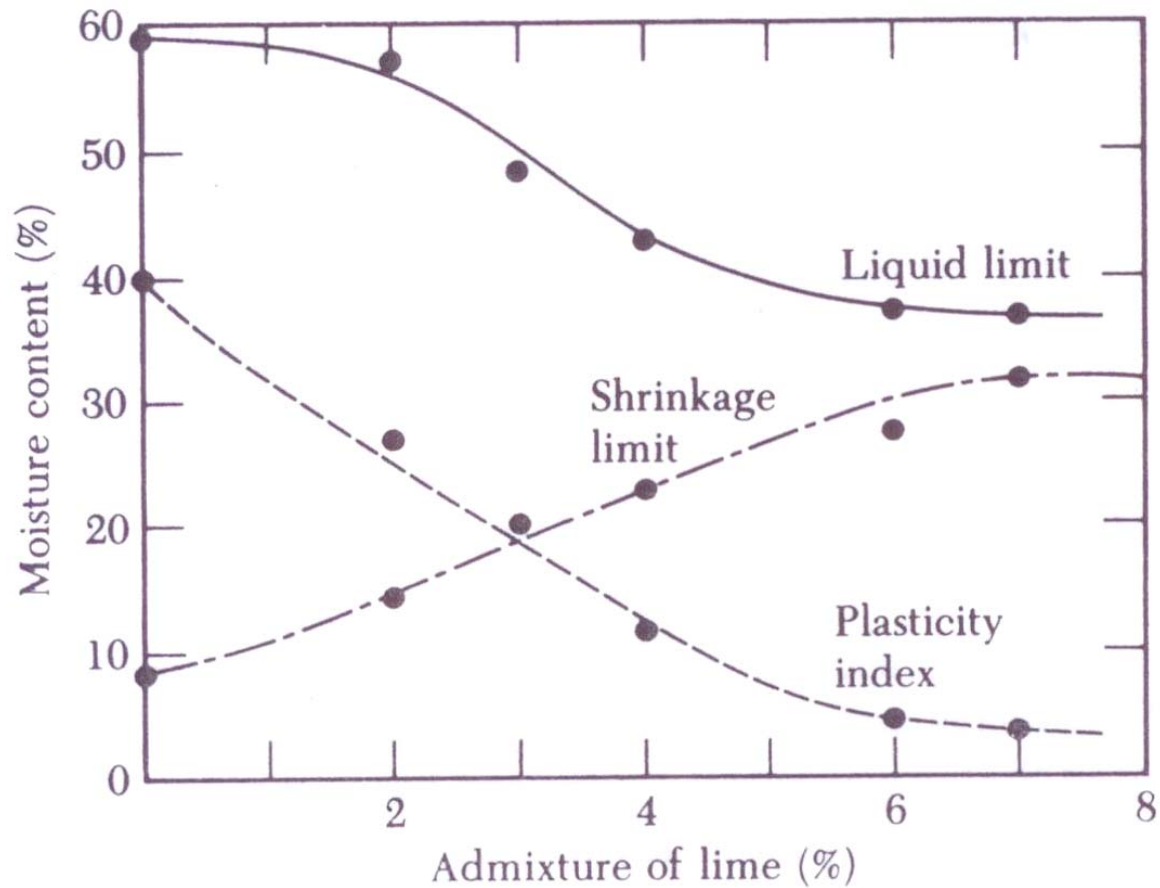

W/D studies

Changes in soil sample (untreated) with Wetting and Drying Cycles



At the start

After Wetting

After Drying

After 1 cycle of wetting and drying

Untreated Paris Clay

W/D studies

Changes in soil sample (treated) with W/D Cycles



At the start

After 3 cycles

After 5 cycles

After 7 cycles

Lime Treated Paris Clay

Results: Bryan Clay

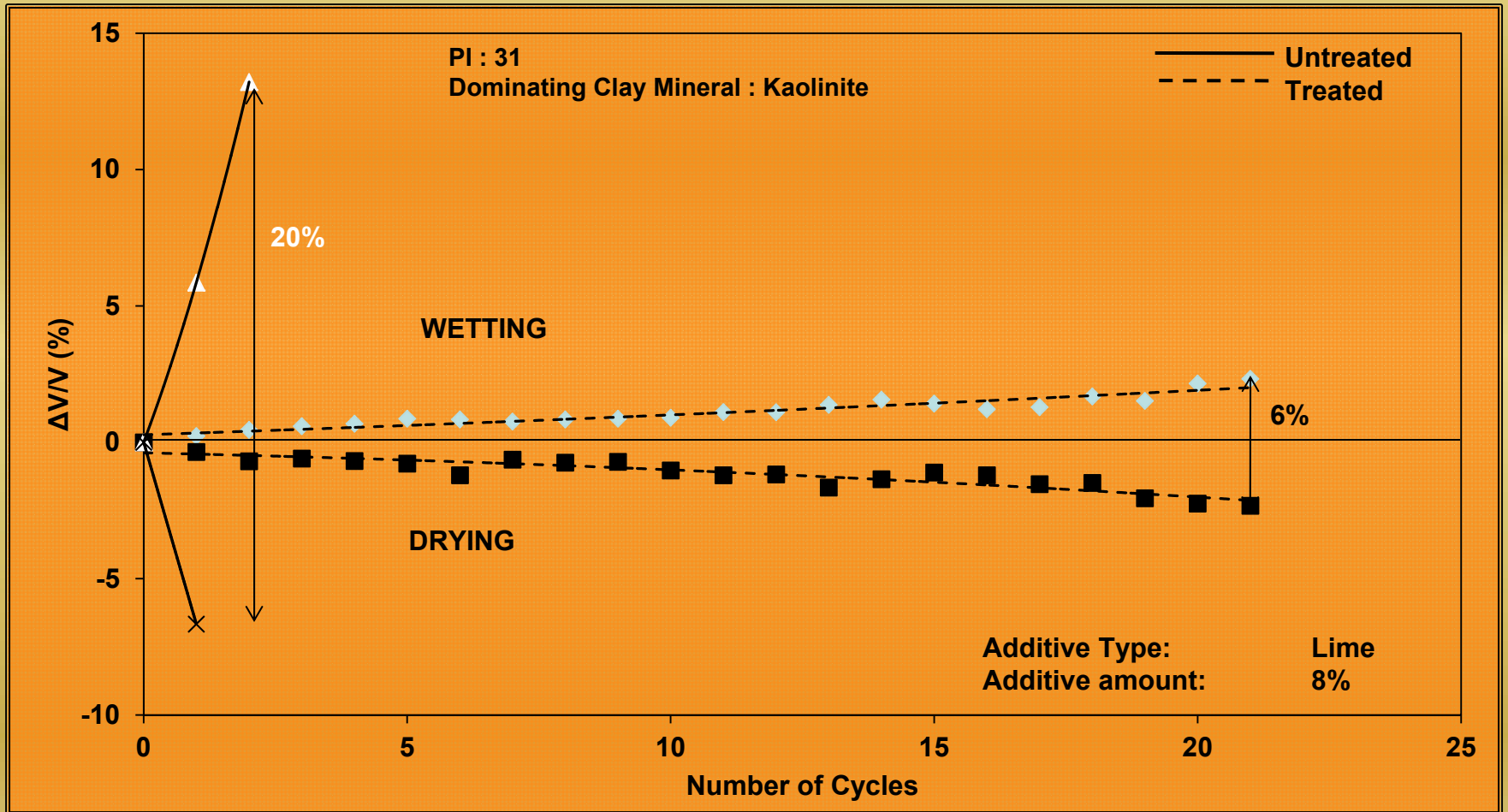

Change in volumetric strain with different W/D cycles

Results: Bryan Clay

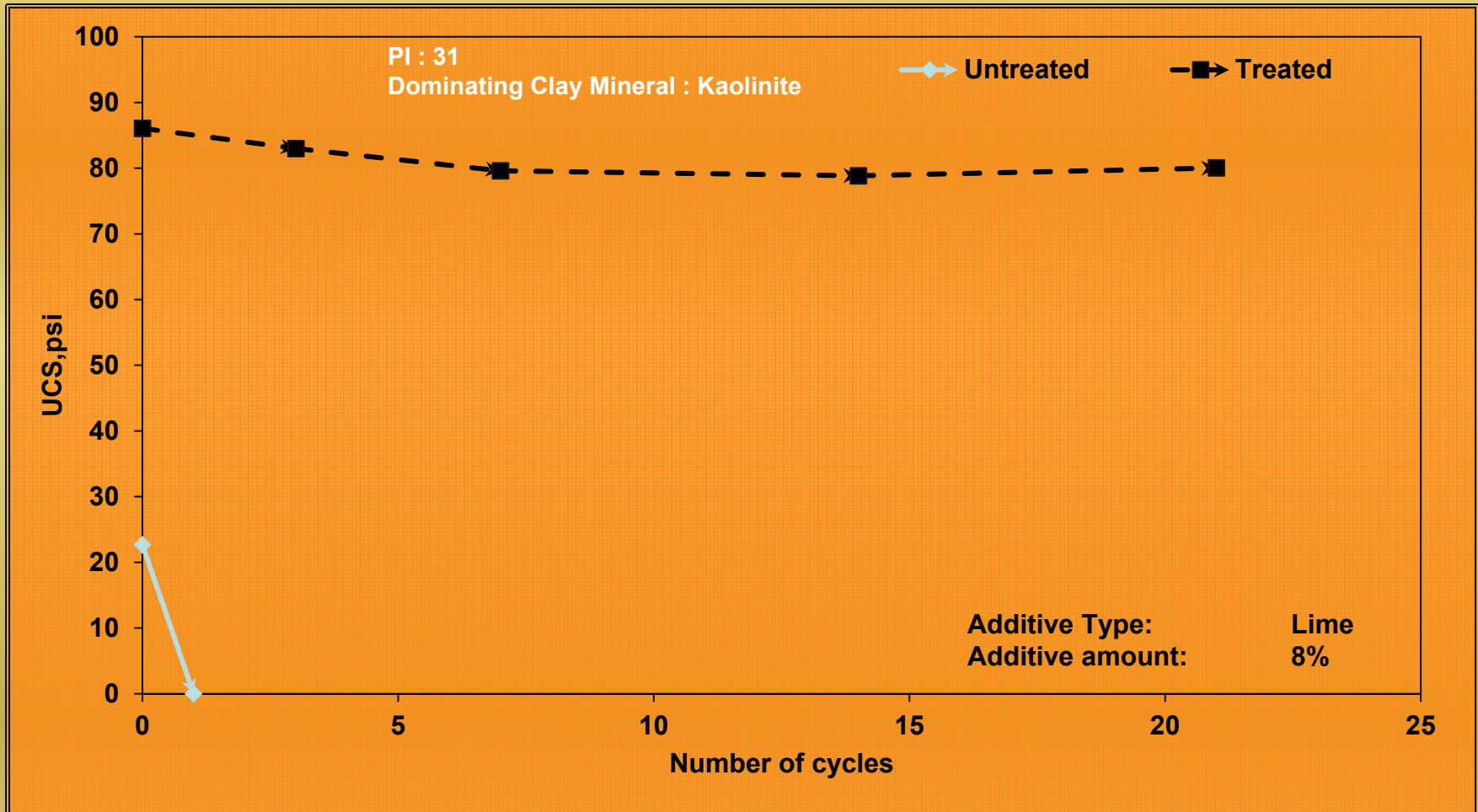

Change in UC strength with different W/D cycles

Results: Fort Worth Clay

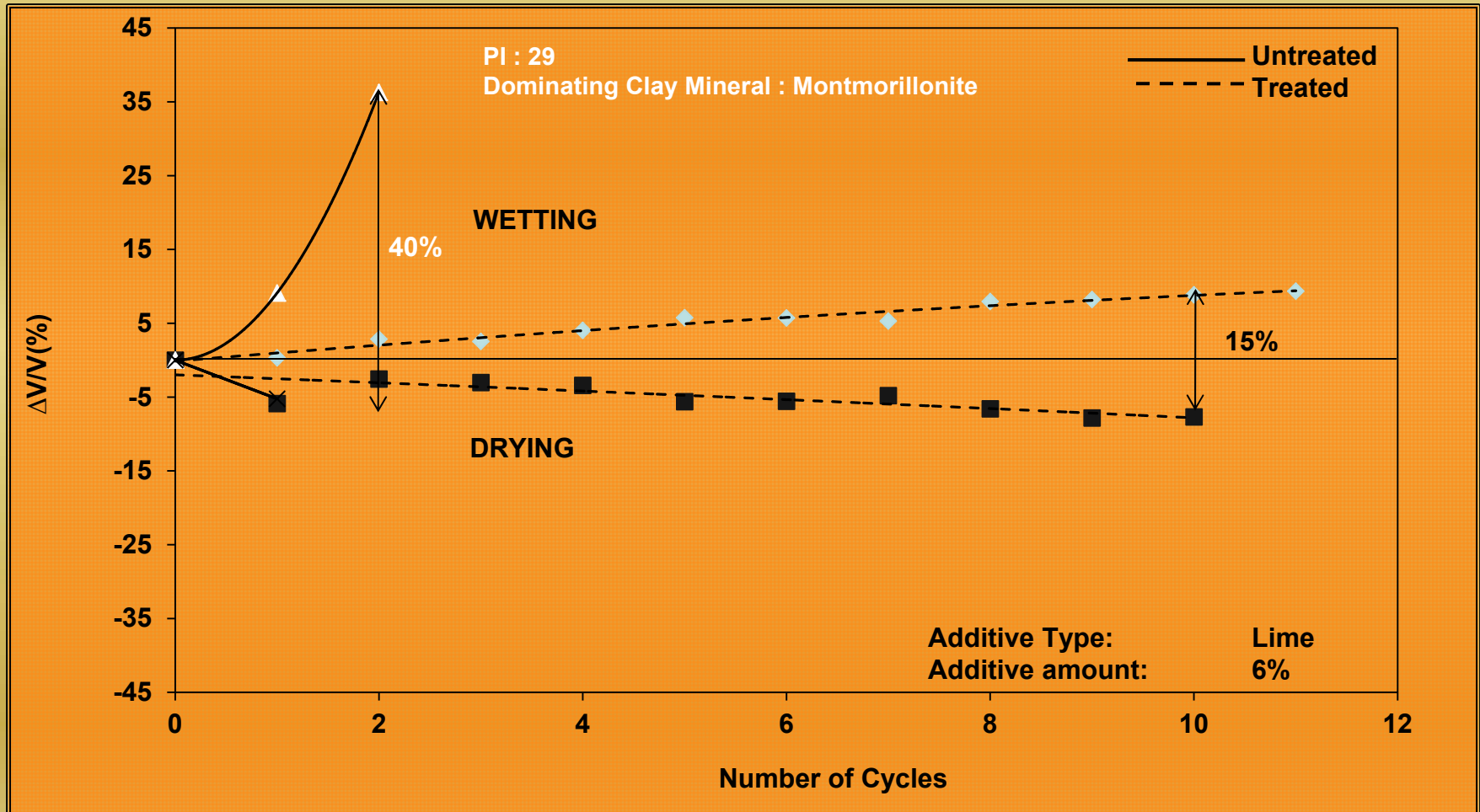

Change in volumetric strain with different W/D cycles

Results: Fort Worth Clay

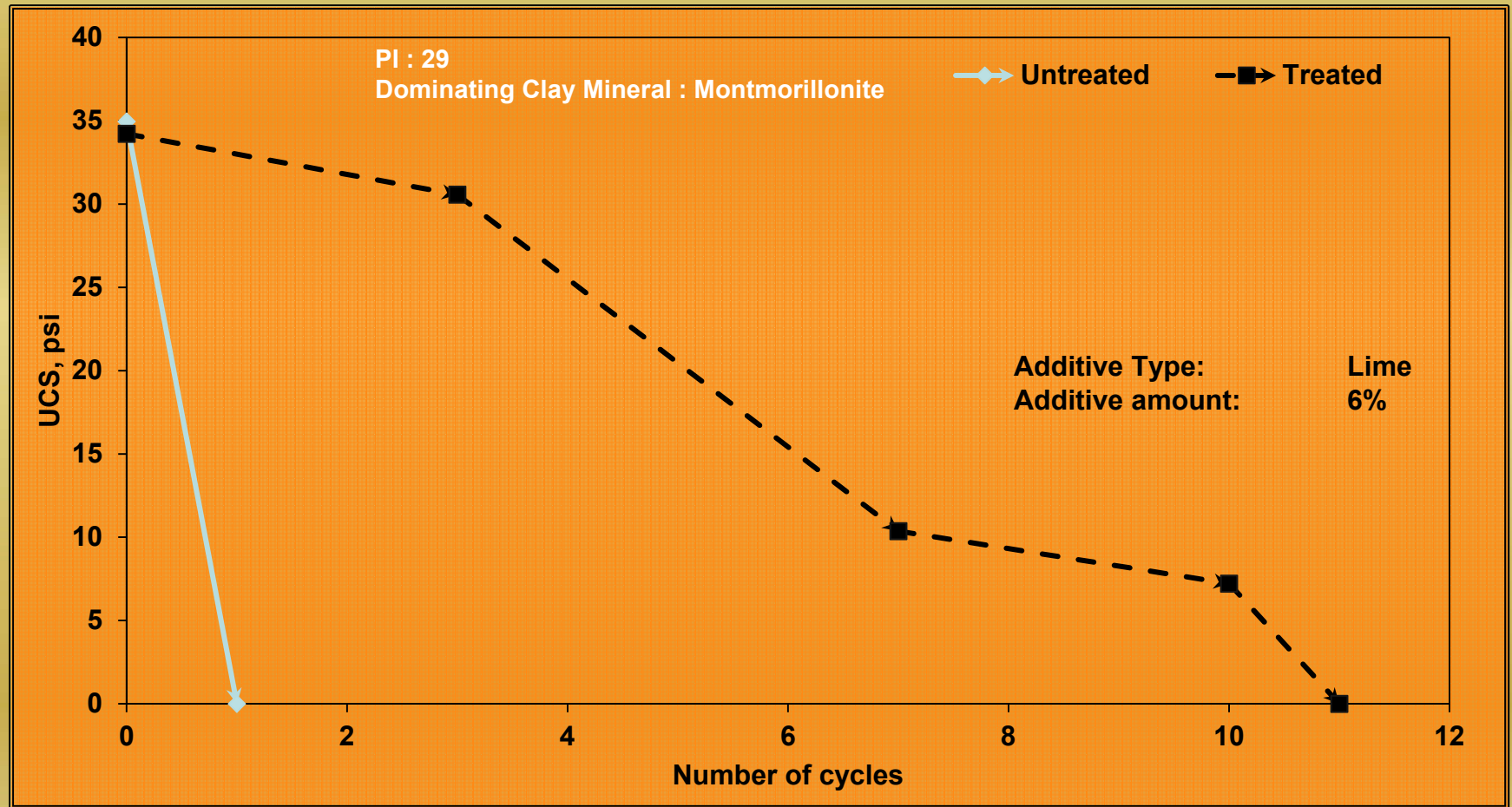

Change in UC strength with different W/D cycles



Execution

①



②



Preparation of the soil: to remove large elements which might hinder the mixing-in of lime, and it also helps to modify the humidity of the soil. It may be carried out with a ripper, a harrow or a plough.

Spreading: the lime is dispersed using a spreader fitted with a weighing device. The lime is supplied pneumatically to the spreader, either directly from the silo vehicle or by using buffer silos.



Mixing: the purpose of this operation is to spread out the soil while at the same time mixing the lime evenly into it. This work will be done with pulvimixers, rotary paddle mixers, disk ploughs or plough shares

Compaction: when grading, the layer thickness that can be compacted by rolling should be taken into account. After grading, the treated soil has to be compacted using a compacting machine (pneumatic-tyre roller or tamping roller). In warm weather, mixing should be done after two hours to allow for reactions.

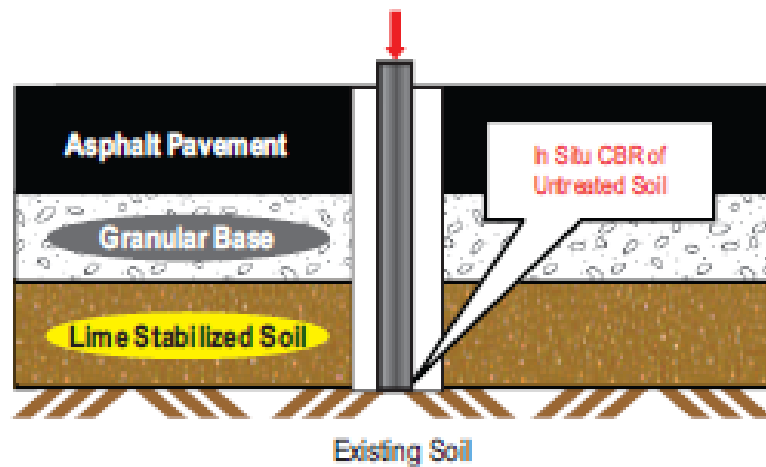
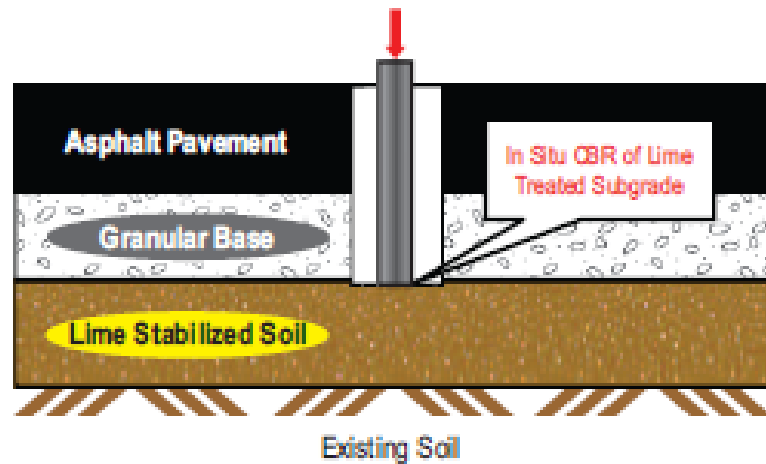

Figure 1: In Situ CBR Measurements

Roadway and Subgrade Soil Characteristics

County	Route Number	Age at Time of Study (yrs)	Plasticity Index Range of Untreated Subgrade (%)	Amount of Lime Added (%) *	In Situ CBR of Untreated Subgrade (avg)	In Situ CBR of Lime Stabilized Subgrade (avg)
Anderson	US 127	11	6 - 21	4	2.0	40.5
Boyle	US 127	12	24 - 41	5	2.4	40.2
Fayette	US 125	8	16 - 45	5	3.1	31.7
Hardin	US 62	13	11 - 33	6	3.0	101.4
Owen	US 127	12	14 - 20	5	3.0	41.3
Shelby	KY 55	10	17 - 26	5	3.1	25.9
Trigg	US 68	9	14 - 23	5	6	91.7

*By dry weight of soil

Table 1: Roadway and Subgrade Soil Characteristics

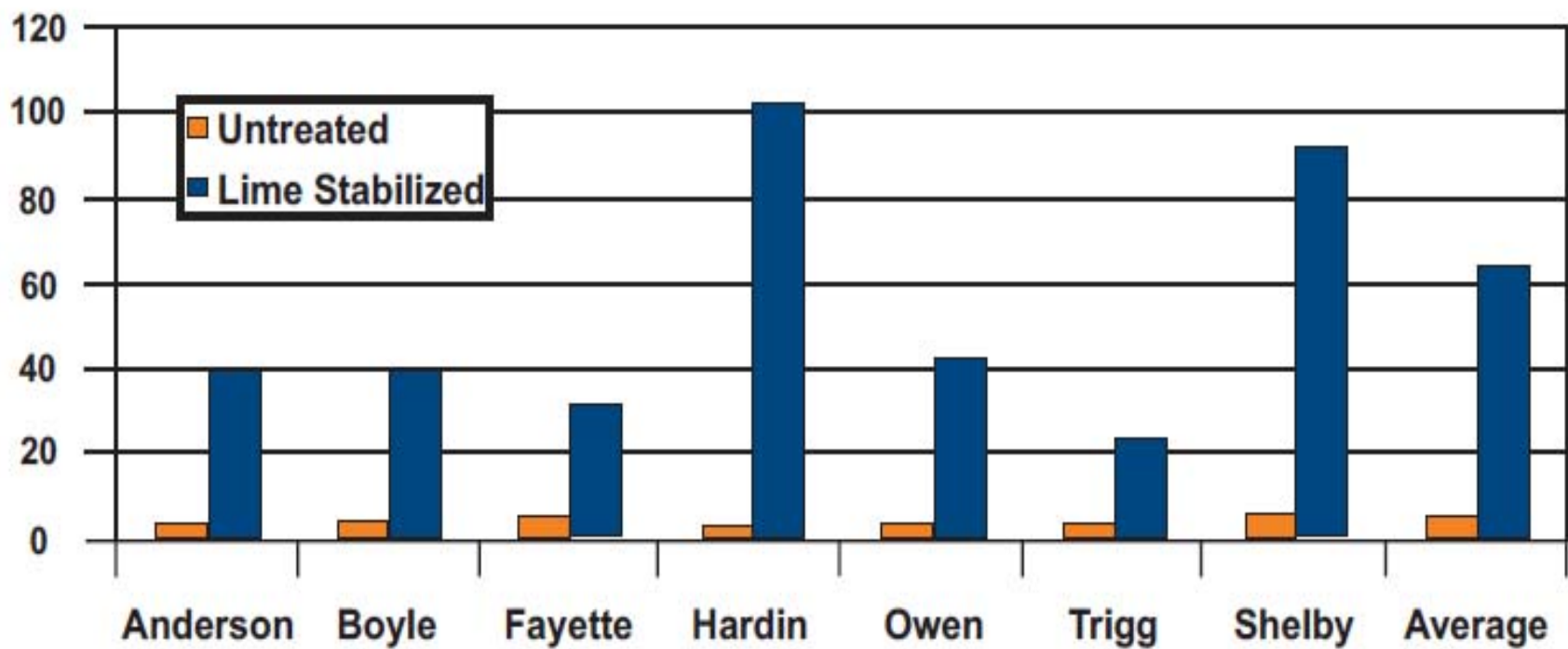

Figure 2: In Situ CBR Values of Untreated and Lime Stabilized Pavement Subgrade

Advantages

- Limitation of the need for embankment materials to be brought in from outside and the elimination of their transporting costs.
- Reduction of transport movements in the immediate vicinity of the construction site. Machines can move about with far greater ease.
- Delays due to weather conditions are reduced, leading to improved productivity. As a result, the overall construction duration and costs can be dramatically reduced.
- Structures have a longer service life (embankments, capping layers) and are cheaper to maintain.

Lime Columns

- Broms and Bomans (1975, 1979) used a special type of auger to form the bores in which lime was mixed with the soil in-situ.
- In this technique it was assumed that the improved soil column in the bore was acting as a pile to support the superstructure.
- Later it was found that lime can diffuse in to the surrounding soil and can stabilize a greater volume of soil.

Typical installation process of lime piles.

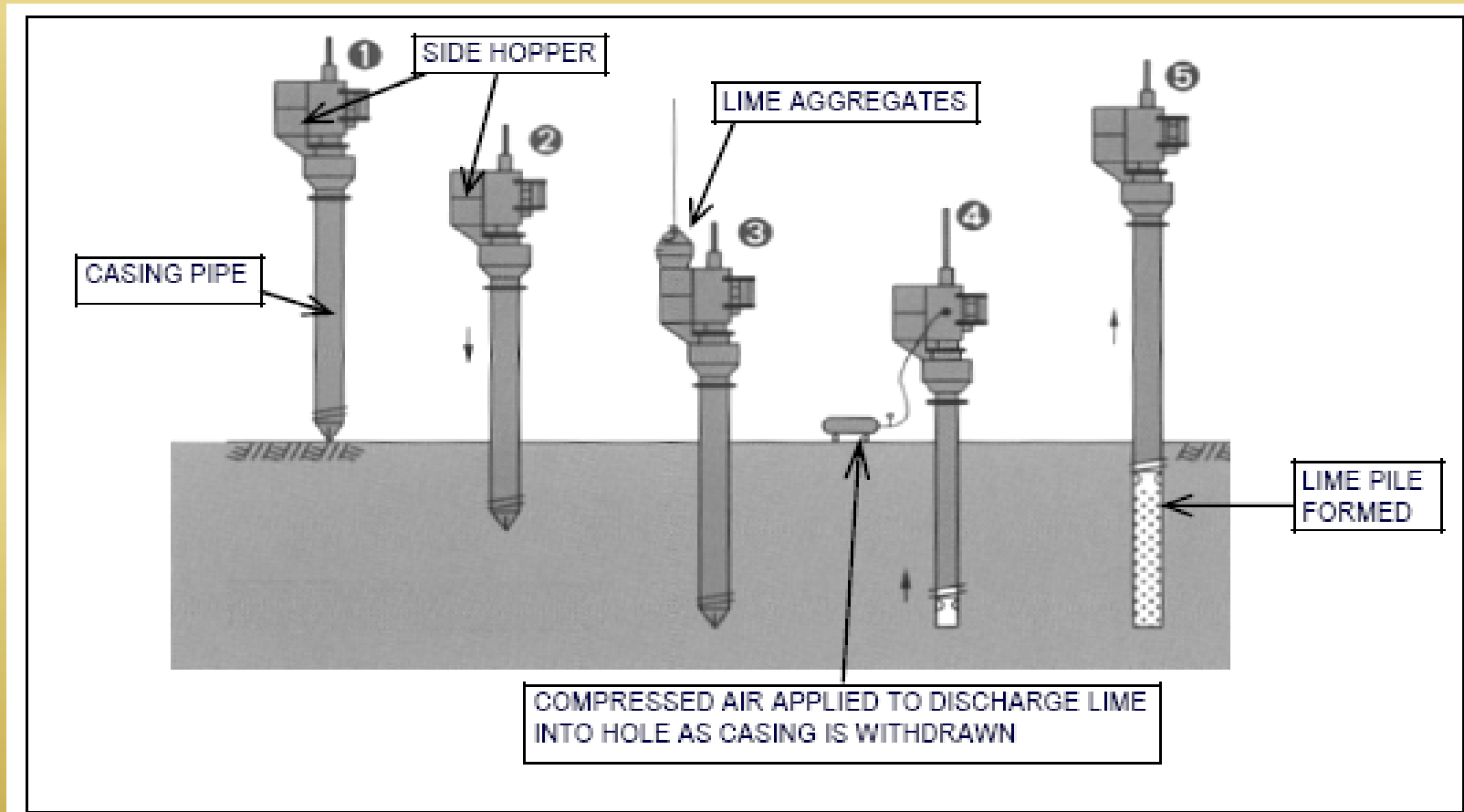

This method produces both a consolidation and strength gain effect on the treated soil, without additional loading, via lateral expansion of the lime columns as they absorb water from the soft soil.

These lime columns have the following effects on the adjacent soil.

a) Consolidation / dewatering effect

Quick lime, CaO, absorbs water from the surrounding ground, causing the lime to swell and forms slaked lime (Ca(OH)₂) as per the following chemical reaction



b) Ion exchange effect

As the surface of fine particles of clay is negatively charged, calcium ions (Ca⁺⁺) from the slaked lime are absorbed by the surface of clay particles. As a result, clay particles are bonded with each other and the weak clay is improved with a resultant increase in shear strength.

c) **Pozzolanic effect**

Calcium ions continue to react with SiO_2 and Al_2O_3 in the clay for a long time forming compounds that cause the clay strength to be improved. This reaction is termed a pozzolanic reaction. The lime piles themselves have considerable strength and therefore act to reinforce the soil as well as alter its properties.

Among all the three effects only consolidation/dewatering effect is the main process by which the strength and stiffness of the soil mass is improved in the shorter term. Other two effects ion exchange effect and pozzolanic effect are ignored.

Shear strength improvement

Comments

The shear strength of the soil stabilized in the field (in situ) was much higher than that of the samples prepared in the laboratory. The soil stabilized in situ is subjected to a pressure from the overburden and from the surrounding soil while the confining pressure for the samples that were stored in small containers in the laboratory is small.

Settlement improvements

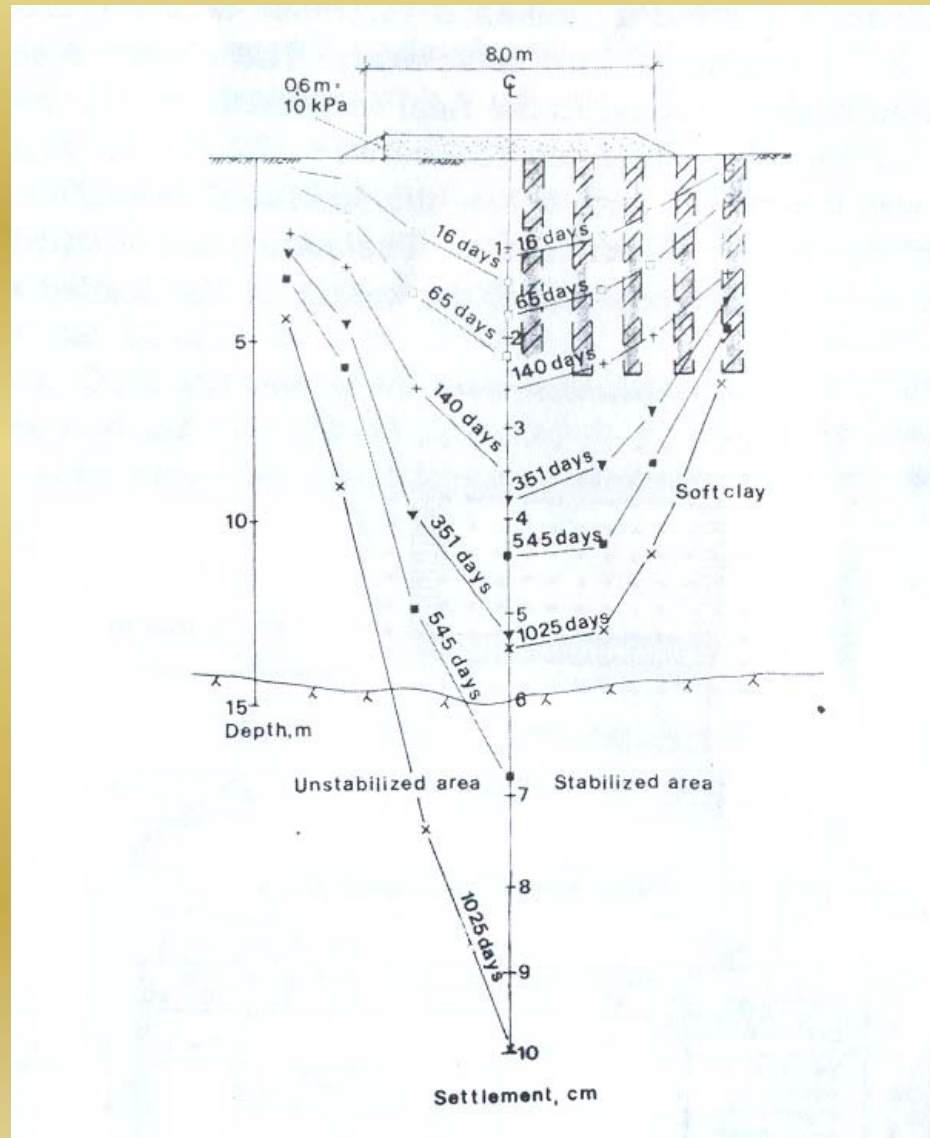

Design of Foundation on lime columns

Laboratory investigations are generally required to estimate the amount of lime required to reach the desired column strength and the required reduction of the compressibility of the soil. Normally 5%-8% unslaked lime is added.

Ultimate bearing capacity

The ultimate bearing capacity and the creep strength can be estimated from the shear strength of samples prepared in the laboratory and stored in a moist room at the anticipated ground temperature.

The ultimate bearing capacity of the lime columns is also affected by the confining pressure from the surrounding unstabilized soil during the curing of the columns.

This effect will increase with increasing confining pressure and thus with increasing depth.

Ultimate bearing capacity

The factor of safety with respect to bearing capacity failure will usually be sufficient ($F_s \geq 2.0$) for light structures even without considering the strength increase from the lime columns when the unit load from the structure is as high as 20 kN/m^2 and the average undrained shear strength of the untreated soil is as low as 7 kN/m^2 .

Differential Settlement

The test results obtained indicate that the differential settlement will be small as long as the average shear stress along the periphery of the reinforced block is less than the average shear strength of the surrounding soil.

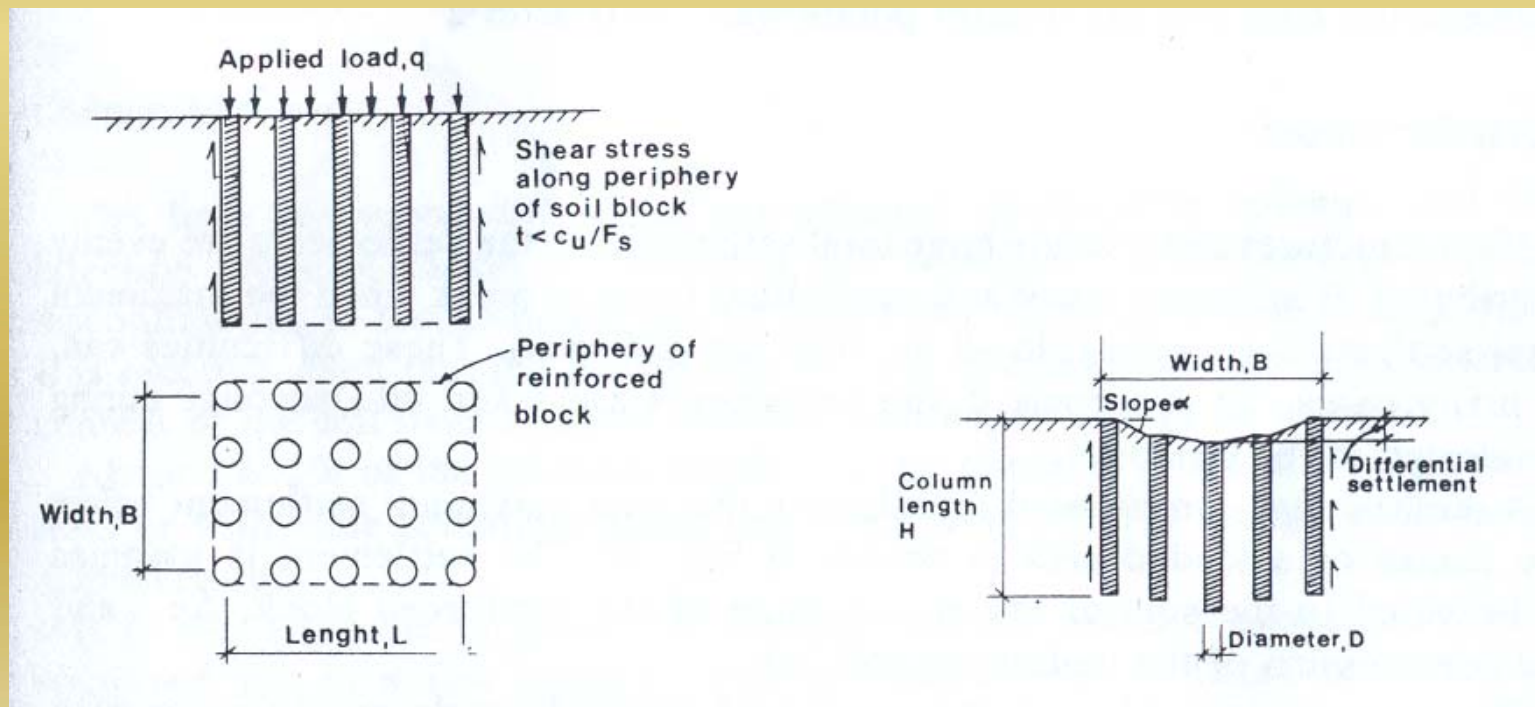

Differential Settlement

The perimeter shear stress (t) can be calculated from the following equation when the load transferred through the bottom of the stabilized area is neglected.

$$t = W/2(B+L)H < c_u/f_b$$

W = weight of the structure; f_b = factor of safety (1.5)

When the load is unevenly distributed, the columns could be concentrated at the parts of the structure with the highest unit load.

Differential settlement

Method of Estimation

The angle change (α) at the edge of the reinforced block will, at low stress levels, increase approximately linearly with the shear stress (t).

$$\alpha = t/G_B$$

G_B = equivalent shear modulus of the soil that depends on the stiffness and the dimensions of the lime columns.

$$G_B = B/(B-nD) * G_{\text{clay}}$$

n = number of column rows; D = column dia.

G_{clay} = shear modulus of the unstabilized clay

Total Settlement

Most structures can tolerate large total settlement if the settlements are evenly distributed. Connecting water and sewer lines begin to break when the total maximum settlement exceeds 150-200 mm.

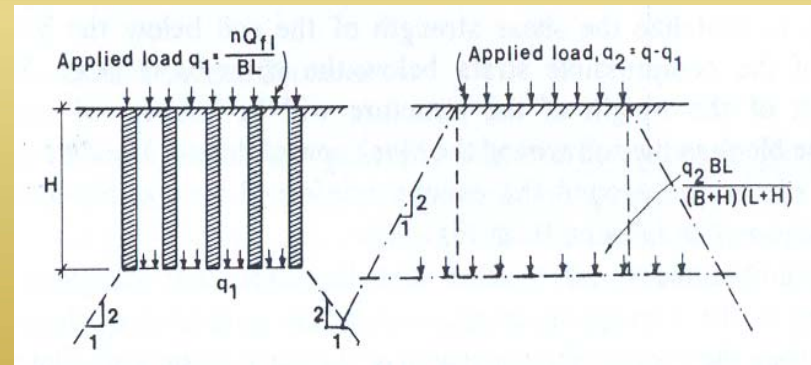
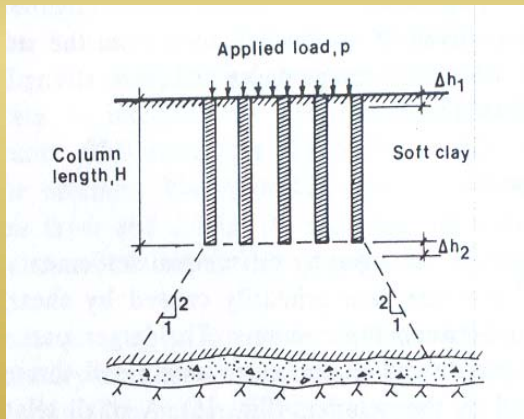

To calculate the total settlement below the center of the loaded area, the settlement is assumed to be equal to the sum of the compression of the reinforced block (Δh_1) and the compression of the underlying soil (Δh_2)

Total Settlement

The compression Δh_1 depends on the interaction between the columns and the enclosed unstabilized soil. Measurements indicate that the compression of the columns is the same the compression of the unstabilized soil between the columns.

Case (1):

When the applied load is very high such that the plastic limit (Q_{cr}) of the column is reached

Case (2):

The applied load and the deformation of the block are small so that plastic limit is not exceeded.

Total Settlement

Case 1:

The settlement can be estimated by dividing the applied load in two parts q_1 and q_2 , in which q_1 is the part carried by the columns and q_2 is the part carried by enclosed soil.

q_1 carried by the column is dependent on the creep limit ($0.7c_{u,col}$) of the stabilized soil.

The settlement Δh_2 caused by load q_2 can be calculated from consolidation tests on undisturbed samples.

Total Settlement

Case 2:

The relative stiffness of the columns with respect to the enclosed unstabilized soil will govern the stress distribution.

The settlement Δh_1 of the reinforced block will be governed by the compression modulus of the column material.

$$\Delta h_1 = q^{\text{col}} H / M^{\text{col}}$$

q^{col} = the average axial stress in the column

H = column length

Total Settlement

Case 2:

Results from the plate load tests (Broms and Boman 1979) indicate that the compression modulus (M^{col}) for short term loading is about $300q_{u,col}$.

Due to consolidation, the value decreases with time to approx. half the initial value. $q_{u,col}$ is the ultimate unit strength of the columns.

Compression modulus of the enclosed unstabilized soil:

Overconsolidated soil: approx. $M_{soil} = 250c_u$

Normally consolidated soil : from consolidation tests

Total Settlement

At equal deformation of the soil and the columns, the following relationship must be satisfied.

$$q_1 BL/nA_{col} M_{col} = q_2 BL/(BL-nA_{col}) M_{soil}$$

n = no. of columns; A_{col} = x-sec. area of column

If area ratio is defined as: $\rho = nA_{col}/BL$

The settlement

$$\Delta h_1 = qH/\rho M_{col} + (1-\rho)M_{soil}$$

It is also recommended to calculate the settlement of the soil below the block.

Case 1: q_1 is transferred to the bottom.

Case 2: q is transferred to the bottom.

Quality Control Measures

The lime consumed during the manufacture of the lime columns should be measured and recorded continuously to prevent discontinuity in the columns and to detect any clogging of the feeding unit.

The distribution of lime in a few columns and the water content of the soil from samples obtained with auger boring be checked.

About 1 to 3% of the columns should be checked with SPT or with vane soundings along the entire length 1 or 2 months after being manufactured.

Check the strength and deformation properties of the stabilized soil in few columns with in situ tests.

Another Method for evaluation of strength and stiffness gain

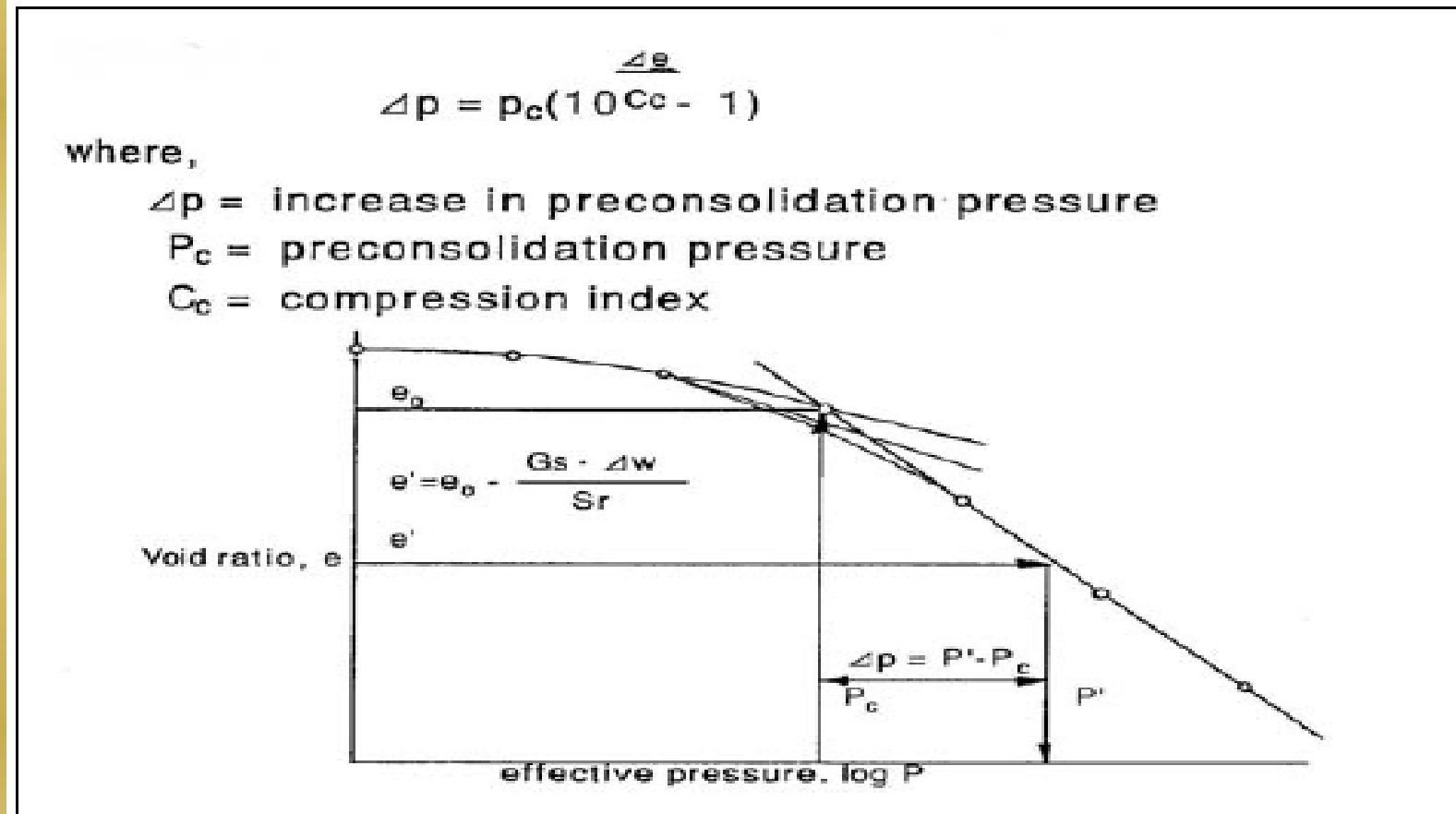

Equivalent Effective Pressure Increase Due to Void Ratio Reduction

For estimating the increase in shear strength of the treated ground by lime piles, following semi empirical formulae are used (Wong 2004)

1) The general area ratio is computed as:

$$A_p = \pi d_0^2 / 4s^2$$

where A_p = area ratio of lime piles, d_0 = diameter of lime pile (often 0.4m), s = spacing of piles (assuming a square grid pattern of lime piles and taking as 1m)

$$(A_p = 0.1256 \text{ m}^2)$$

2) The reduction in water content of treated soil is

$$\Delta w = \left[(100 + w_0) / \gamma_t \right] A_p \left\{ h\gamma_c + \left[n'(1 + \varepsilon_v)(S'_r / 100)\gamma_w \right] \right\}$$

Δw = reduction in water content of treated soil, w_0 = original water content of soil (% taken as 80% for illustration), γ_t = unit weight of untreated soil ($\text{kN/m}^3 = 18$), h = absorption value of water by lime column and depends on the additives used in preparing the unslaked lime aggregates (a value of 0.3 is often used), γ_c = unit weight of chemical lime (taken as 1.2 t/m^3), n' = porosity of lime column after chemical reaction (a value of 0.55 is often used), ε_v = expansion ratio of lime column (a value of 0.75 is often used), S'_r = degree of saturation of lime pile after treatment (a value of 80% is often used) and γ_w is unit weight of water (10 kN/m^3)

Δw is obtained as 5.5%.

3) The equivalent change in void ratio of the improved ground is given by

$$\Delta e = G_s \Delta w / S_r \quad (0.1485)$$

Δe = reduction in void ratio, G_s = specific gravity of original soil ($G_s = 2.7$), Δw = reduction in water content, S_r = degree of saturation of original soil (100% for most soft clays)

4) The new void ratio is $e' = e_0 - \Delta e$

Initial void ratio is 2.16 and hence new void ratio is 2.011

5) The increase in confining pressure due to the improved soil is calculated as :

$$\Delta p = p_c \left(10^{\Delta e / C_c} - 1 \right)$$

Δp = increase in pre-consolidation pressure, 76.8 kPa

p_c = original pre-consolidation pressure ($p_c = 100$ kPa)

C_c = compression index ($C_c = 0.60$)

6) The increased shear strength, s_t , of the treated soil is :

$$s_t = s_0 + (s_u / p') \Delta p$$

s_0 = shear strength of untreated soil, s_u/p' = shear strength ratio is taken as 0.3. This gives s_0 value of 28.04 kPa. The strength of the composite ground (soil plus piles), s_t' , can be estimated as:

$$s_t' = A_p s_p + (1 - A_p) s_t$$

where s_p = shear strength of lime pile (200 kPa is reasonable). This gives a value of s_t' as 49.7 kPa.

7) The reduction in settlement can be considered using the following equation:

$$\Delta S = H_c \Delta e / (1 + e_0)$$

where ΔS = preconsolidation settlement due to lime piles (settlement reduction) and H_c = thickness of soft clay treated by the lime piles is 470 mm.

8) The drained modulus of the treated soil, E_t , is

$$E_t \left[(n - 1) A_p + 1 \right] E_s$$

where E_s = drained modulus of untreated soil (10 MPa), A_p = area ratio of lime columns and n = stress distribution ratio (a value of 10 is suggested). This leads to a value of 21.3 MPa.

Case Study

Chemical lime pile ground treatment was applied to the Runnymede Commercial Project in Penang (Malaysia), constructed during 2000 and 2001. For this project, 400 mm diameter lime piles were installed at 1.7m spacing to increase the strength and modulus of an 8m deep soft clay layer. The purposes were as follows:

- To increase the passive resistance and reduce deformation for the shoring wall for the purpose of basement construction.
- To improve traffic ability for construction machinery at the base of the excavation.
- To increase the stiffness of the remaining soft clay layer for a piled raft foundation system that was proposed for the 23-storey tower structure.

SUBSURFACE PROFILE

Stratigraphic Unit	Typical Depth Interval (m)
Soft Clay / Silt	0 to 8
Firm Clay / Silt	8 to 13.5
Stiff Clay / Silt	13.5 to 24.5
Dense Sandy Gravel and Gravelly Sand	24.5 to 29.0
Stiff Sandy clay and Silt	29.0 to 54
Very Stiff to Hard Clay and Silt	54 to > 120

SOIL PROPERTIES OF UPPER SOFT CLAY LAYER

Borehole	Depth (m)	N.M.C. (%)	WL	WP	PI	Silt (%)	Clay (%)
BH1	6 to 6.5	97.1	65	35	30	55	42
BH2	2.5 to 3.5	100.7	54	29	25	57	38
BH2	5.5 to 6.5	110.3	55	30	25	56	42
BH2	5.5 to 6.5	110.3	55	30	25	56	42
BH4	3.5 to 4.5	104.7	58	29	29	52	44
BH5	6 to 6.45	94.1	54	27	27	53	43
Minimum	—	94.1	54	27	25	52	38
Maximum	—	110.3	65	35	30	57	44
Average	—	102.9	56.8	30	26.8	54.8	41.8

The original soil shear strength obtained from vane shear testing was 15 kPa for 5m of top soft soil and then increasing to about 30kPa at about 8m depth.

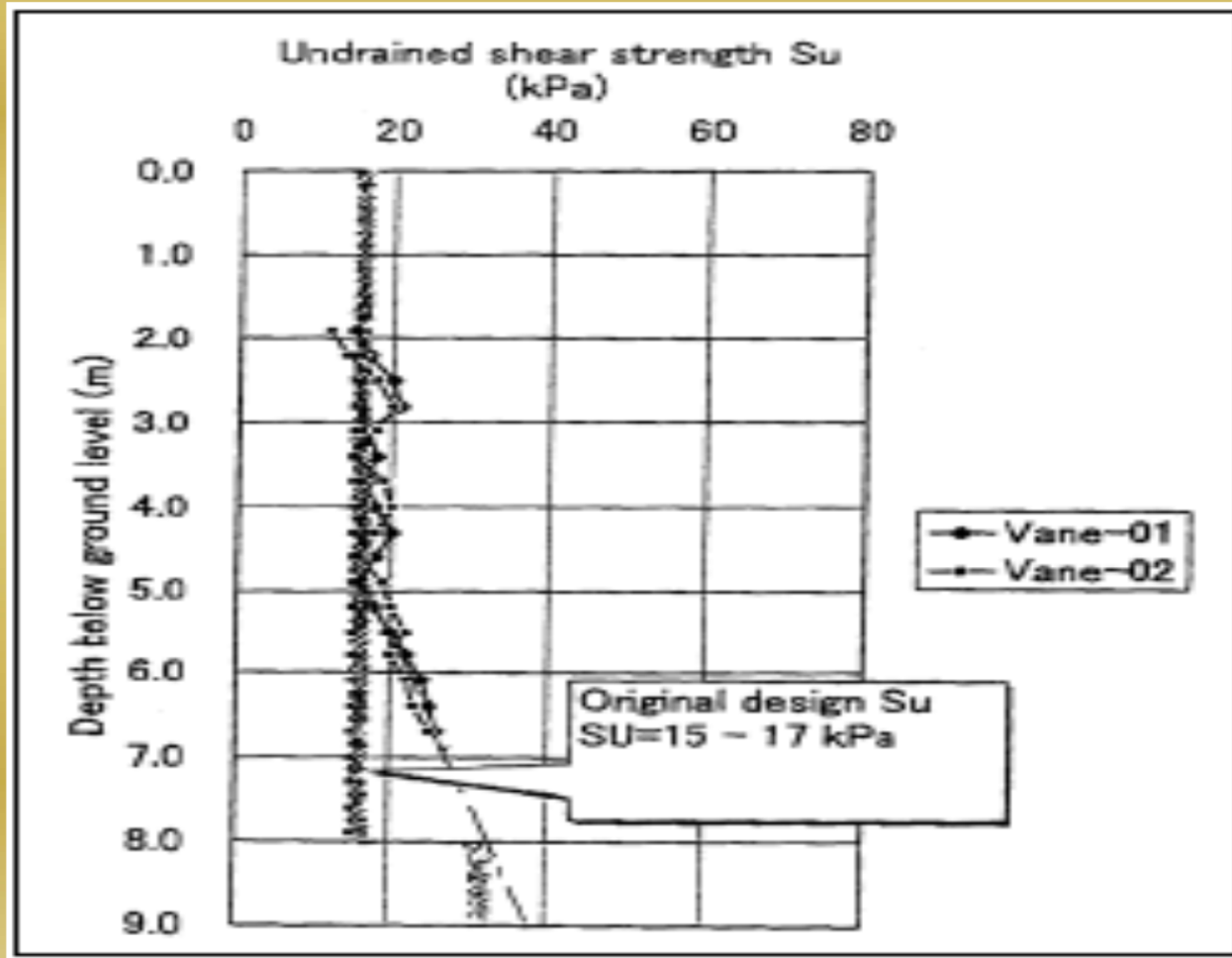

Vane Shear Test Results for Untreated Ground

Field Performance

Approximately 5 weeks following the installation of the lime piles, field vane testing indicated that the shear strength of the soil at the quarter point between the lime columns had increased to between 27 and 36 kPa in the upper 5m of soil.

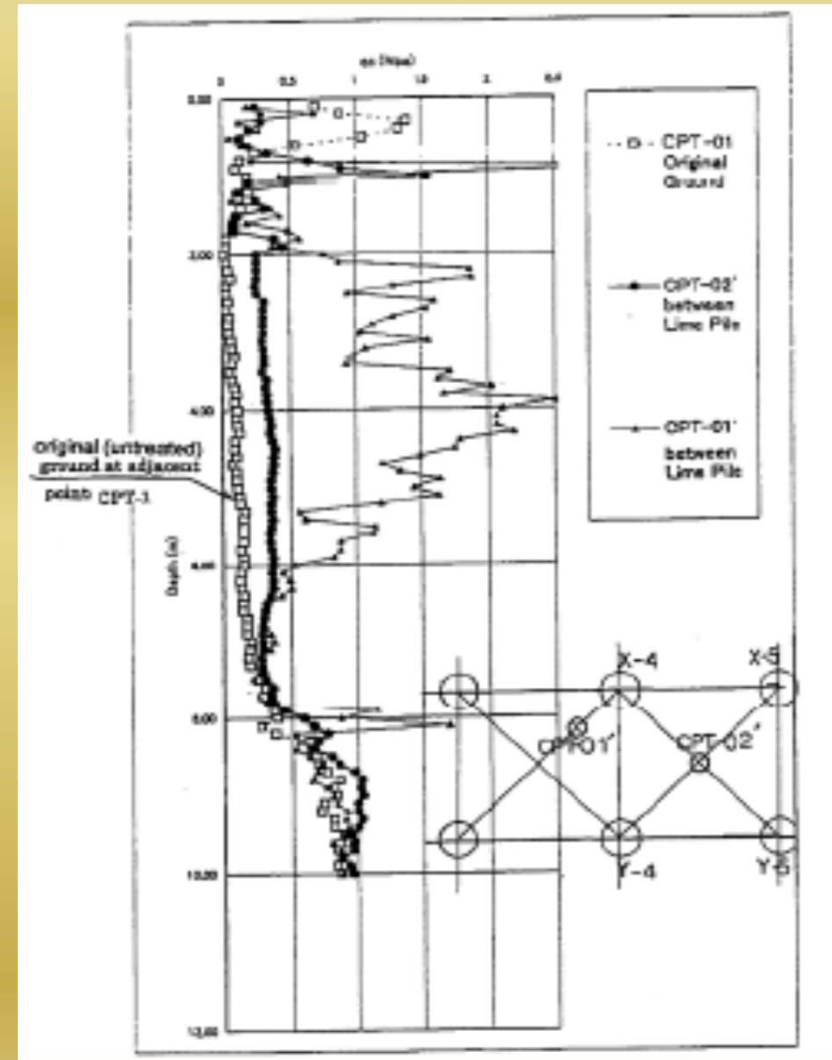

Comparison of CPT Results Before and After Lime column installation

A case study of expansive soil in a power Station





Presence of expansive soil layer beneath the moorum layer

MEASUREMENTS OF TILT OF FOUNDATION AT TOWERS

Results indicate that the vertical tilt is high as 2° and the differential settlement is about 20 mm in some cases. The height of the pole is about 2m and hence the tilt value is 69.00mm, whereas it is understood from the client that the permissible value is $L/300$ mm which corresponds to 6.67 mm. Hence the observed tilt is not acceptable. In addition, the permissible differential settlement for isolated foundation is 1 to 150. This value corresponds to a differential settlement of 6.67 mm for 1m footing and 10 mm for 1.5m footing respectively. The observed value of 20 mm is in excess of the above values.

Remedial measures

Treatment of the expansive soil area using lime and fly ash slurry, foundation rehabilitation and drainage measures are suggested towards possible improvement of the ground conditions and foundation response.

Conclusions

Stabilization methods using lime and lime columns can be used in pavements and to support light structures.

The treatment with lime and lime columns can reduce both the total and differential settlement and increase the bearing capacity of the soil.

Durability tests confirm the usefulness of the techniques.

References

- <http://www.carmeusena.com/>.
- Hopkins, T.C., Beckman, T.L., Sun, L., Ni, B., and Butcher, B. “Long-Term Benefits of Stabilizing Soil Subgrades,” Research Report KTC-02-19/SPR-196-66-1F, University of Kentucky Transportation Center, College of Engineering, Lexington, Kentucky, 2002. Wong P. K. (2004) “Ground Improvement Case Studies – Chemical Lime Piles and Dynamic Replacement” Australian Geomechanics Society Jnl Vol 39 No.2 June 2004.
- Puppala A (2008) Plenary lecture on design methodologies for expansive clay subgrades, Bangalore.



Thank You