

**Module 3 – (L8-L11): Integrated Watershed Management
Introduction to Integrated Approach, Integrated Water Resources
Management, Conjunctive Use of Water Resources, Rainwater
Harvesting; Roof Catchment System.**

WATERSHED MANAGEMENT

Prof. T. I. Eldho

Department of Civil Engineering,
IIT Bombay

Lecture No- **10** **Rainwater Harvesting System**

L10– Rainwater Harvesting System

- **Topics Covered**
- Introduction to Rainwater harvesting system, Hydrological aspects, Hydro-geological aspects, Groundwater recharge, Integrated system, Case study
- **Keywords:** Rainwater harvesting system, Hydro-geology, Groundwater recharge

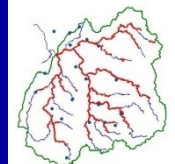

WATERSHED MANAGEMENT

Introduction to Rainwater Harvesting

- Rain Water Harvesting - process of collecting, conveying & storing water from rainfall in an area – for beneficial use.
- **Storage – in tanks, reservoirs, underground storage - groundwater**
- **Necessity: Temporal & spatial variation of rainfall & water availability**

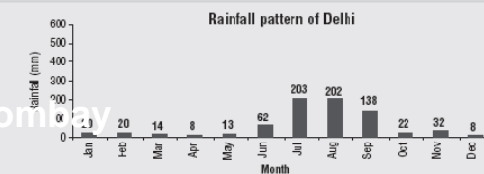
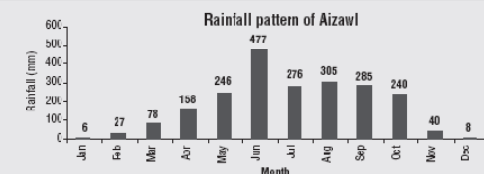
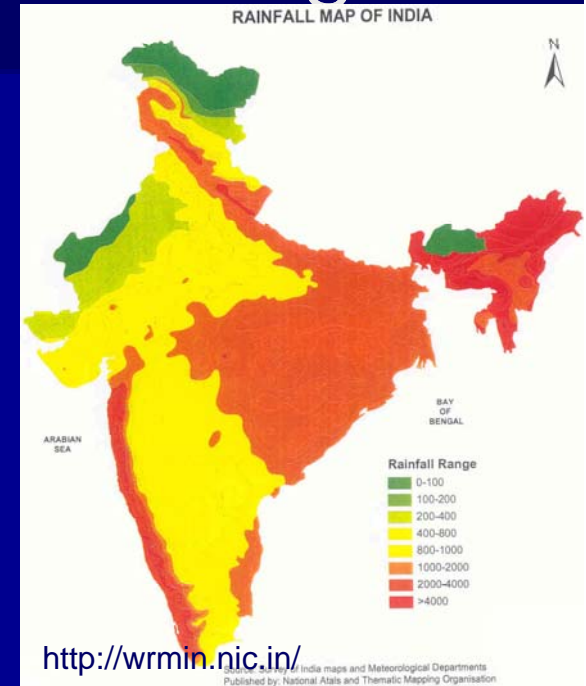

Introduction to Rainwater Harvesting..

- **Rainwater harvesting**- technology used for collecting & storing rainwater from rooftops, land surface or catchments/ watersheds using various techniques such as tanks or check dams or recharge to aquifer.
- Most promising alternatives for supplying freshwater in the face of increasing water scarcity & escalating demand.
- **Basic Components of RWH:**
 - Precipitation
 - Collection of water from surface catchment
 - Water storage
 - Distribution of water



Why Rainwater Harvesting (RWH)?.

- **Rainwater Harvesting** -yield copious amounts of water. For average rainfall of 1,000mm, approximately four million liters of rainwater can be collected in a year in an acre of land (4,047 m²), post-evaporation.
- As **RWH** is neither energy-intensive nor labor-intensive, - a cost-effective alternative to other water-accurring methods, such as desalination of seawater & water transfer.
- With the water table falling rapidly, & with concrete buildings, paved car parks, business complexes, & landfill dumps taking the place of water bodies, RWH is the most reliable solution for augmenting groundwater level to attain **self-sufficiency** in public distribution of water.



Rainwater Harvesting - Purposes

Rainwater Harvesting techniques can serve the following purposes:

- **Two Major Purposes:** Agricultural and human consumption
- Freshwater augmentation technology
- Increase groundwater recharge
- Reduce storm water discharges, urban floods and overloading of sewage treatment plants
- Reduce seawater ingress in coastal areas



Photo, A.K. Singh, 2002

Reservoir in main channel

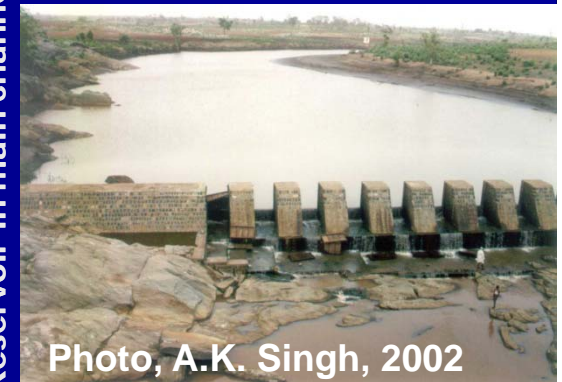

Photo, A.K. Singh, 2002

WATERSHED MANAGEMENT

Photo, A.K. Singh, 2002

Rainwater Harvesting - Methodologies

Water harvesting -undertaken through a variety of ways

- Capturing runoff from rooftops – Roof water harvest
- Capturing runoff from local catchments – Land harvest
- Capturing seasonal floodwaters from local streams
- Conserving water through watershed management
- **For Urban & Industrial Environment** –
 - Roof & Land based RWH
 - Public, Private, Office & Industrial buildings
 - Pavements, Lawns, Gardens & other open spaces



Prof. T I Eldho, Department of Civil Engineering, IIT Bombay



Rainwater Harvesting - Advantages

- Provides self-sufficiency to water supply
- Reduces the cost for pumping of groundwater
- Provides high quality water, soft and low in minerals
- Improves the quality of ground water through dilution when recharged to groundwater
- Reduces soil erosion in urban areas
- Rooftop rain water harvesting is less expensive
- Rainwater harvesting systems are simple which can be adopted by individuals
- Rooftop rain water harvesting systems are easy to construct, operate and maintain.



Rainwater Harvesting – Advantages...

- In hilly terrains, rain water harvesting is preferred
- In saline or coastal areas, rain water provides good quality water and when recharged to groundwater, it reduces salinity and also helps in maintaining balance between the fresh-saline water interface
- In Islands, due to limited extent of fresh water aquifers, rain water harvesting is the most preferred source of water for domestic use
- In desert, where rain fall is low, rain water harvesting has been providing relief to people



Rainwater Harvesting – Technology

- Type of rainwater harvesting structures depends

- Topography
- Availability of land
- Rainfall
- Economic status

- Built-up areas

- Temple tanks
- Rooftop harvesting
- Wells and radiator wells
- Parking lot storage
- Recreational Park ponds

- Open areas

- Percolation ponds
- Infiltration galleries
- Community wells
- Farm ponds
- Ducts
- Anicuts across the streams.

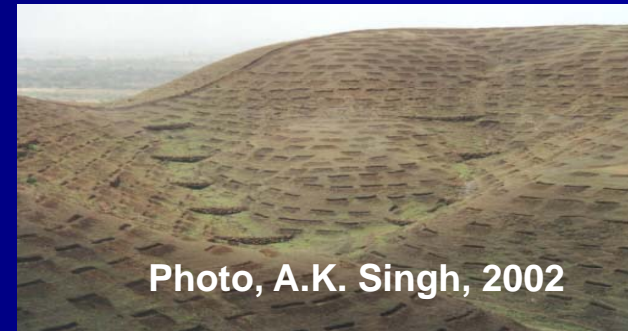

Rainwater Harvesting – Potential

- Water yield from a catchment depends on amount of rainfall, watershed slope, types of soil and vegetation and the evapotranspiration ratio.

Vegetation Management:

- Improved management of vegetation are mainly applicable to large areas
- Water yield from a grass cover is more than that from a forest cover

Land alteration:

- Alteration of land surface of a catchment (pervious to impervious)
- Laying of paved surfaces on sloping catchments along with drains at their sides
- Collection of catchment runoff in storage tanks
- Method is Preferable where the land surface is undulating.



Photo, A.K. Singh, 2002

WATERSHED MANAGEMENT

Hydrological Aspects of RWH

- **Hydrology** - study of water. Although there is plenty of water on earth, it is not always in the right place, at the right time, and of the right quality.
- **Hydrology** -to understand the complex water systems of the Earth and help to solve water problems.
- **Rainfall** – main source of water
- Hydrological Cycle - Change in phase in **Hydrosphere**
- Balance of water on Earth remains fairly constant over time.

Watershed Concept

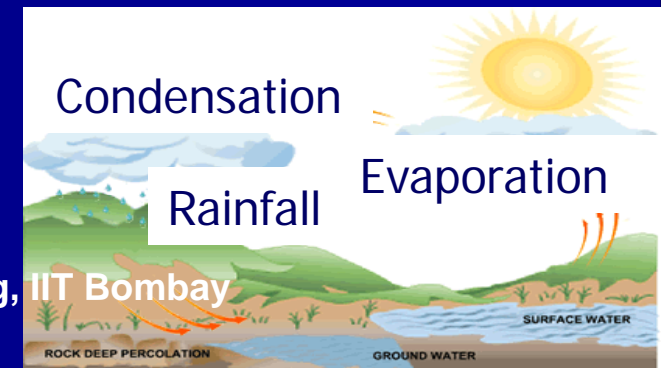
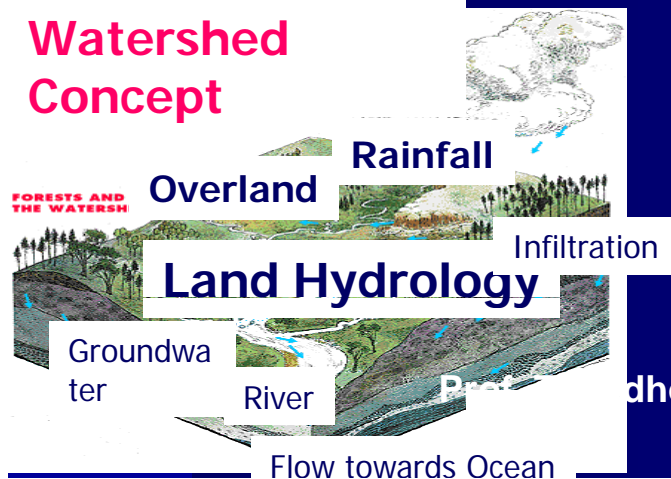

RWH – Rainfall to Runoff

- Various process and pathways determine how much and how fast precipitation becomes stream flow.
- Factors effecting runoff response:
 - Precipitation form, intensity, duration, distribution
 - Storage (soil moisture, saturated areas)
 - Flow pathway (e.g., shallow soil layer vs. deeper soil layer, or overland surfaces or subsurface)
 - Spatial distribution & geomorphic features
- **Meteorological factors:** Type of precipitation (rain, snow, etc.): Rainfall intensity - amount, duration; Distribution of rainfall over the drainage basin, Direction of storm movement, Precipitation that occurred earlier and resulting soil moisture.



How Much Water can be Harvested?

- The total amount of water that is received in the form of rainfall over an area is called the *rainwater endowment* of that area.
- Out of this, the amount that can be effectively harvested is called the *water harvesting potential*.
- $\text{Water harvesting potential} = \text{Rainfall (mm)} \times \text{Collection efficiency}$.
- The *collection efficiency* accounts for the fact that all rainwater falling over an area cannot be effectively harvested, because of evaporation, spillage etc.
- Factors like runoff coefficient is to be considered.



How Much Water can be Harvested?

- Runoff coefficient- factor accounts that all the rainfall falling on a catchment cannot be collected. Some rainfall will be lost from the catchment by evaporation & retention on the surface itself.
- **Runoff coefficients for various surfaces**
- Type of Catchment Coefficients
- **Roof Catchments:** Tiles 0.8 – 0.9; - Corrugated metal sheets 0.7 – 0.9
- Ground surface coverings- Concrete 0.6–0.8; Brick pavement 0.5–0.6
- Untreated ground catchments - Soil on slopes less than 10 per cent 0.0 – 0.3; Rocky natural catchments 0.2 – 0.5

Source: Pacey, Arnold and Cullis, Adrian 1989, Rainwater Harvesting: The collection of rainfall and runoff in rural areas, Intermediate Technology Publications, London, pg. 55

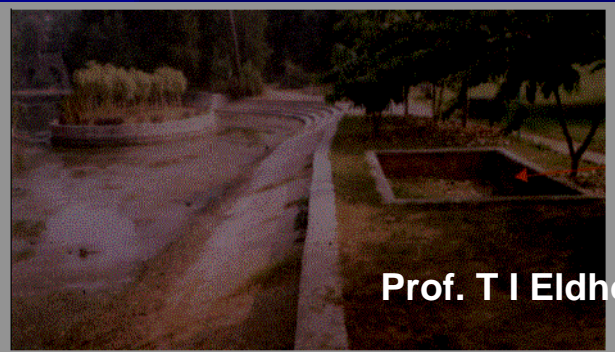

WATERSHED MANAGEMENT

How Much Water can be Harvested?

$$\text{Area of catchment (sq.m)} \times \text{Amount of rainfall} = \text{Volume of water received (cu.m)}$$

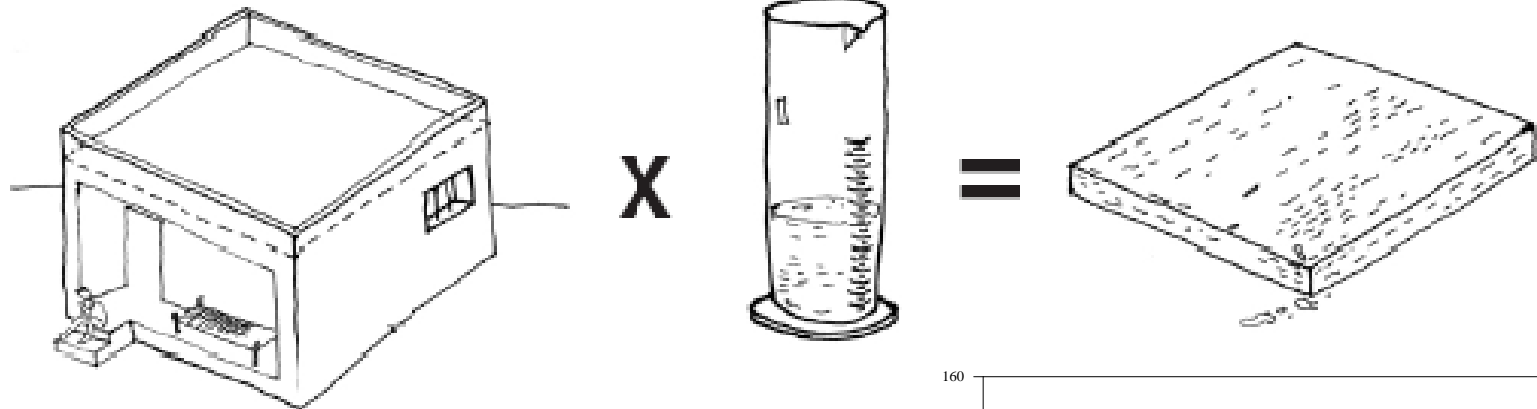

■ www.cseindia.org

Prof. T I Eldho, Department of

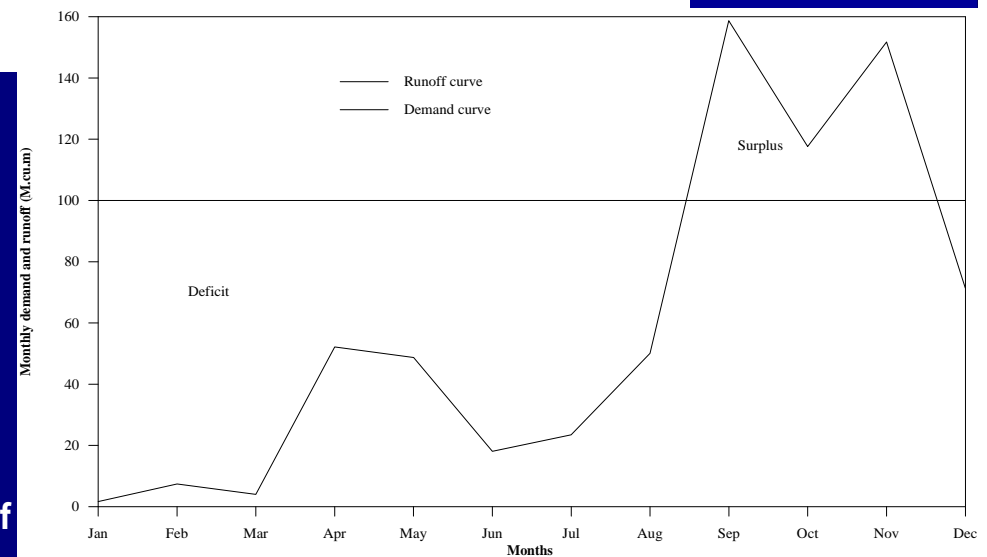

Fig. 2. Comparative plot of monthly demand and runoff

RWH – Calculation?

- Consider a building with a flat terrace area of 100 sq. m. The average annual rainfall be approximately 900 mm. It means that if the terrace floor is assumed to be impermeable, and all the rain that falls on it is retained, then, in one year, there will be rainwater on the terrace floor to a height of 900 mm.

Area of plot = 100 sq. m.

Height of rainfall = 0.9 m (900 mm)

Volume of rainfall = Area of plot x Height of rainfall
= 100 sq. m. x 0.9 m = 90 cu. m. (90,000 liters)

Assuming that only 70% of the total rainfall is effectively harvested,

Volume of water harvested = 63,000 liters (90,000 litres x 0.7).

How Much Water Can be Collected ?

- **Collection Efficiency**

How efficiently the rainfall can be collected depends on several considerations. Collection efficiencies of 80% are often used depending on the specific design.

- Rainfall Reliability.

The main step is to determine how much water would be generated from the roof area. Average monsoon rainfall is used for this purpose.

- Formula:

- Total quantity of water to be collected (cu.m.) = Roof Top Area (Sq.m.) x Average Monsoon Rainfall (m) x Collection efficiency

Rainfall Distribution in India

- Because of distinctive climate – Intense monsoons followed by protracted droughts - storage of rainwater at appropriate sites becomes imperative.
- Eighty percent of annual rainfall of 1170 mm is received during three months period.
- During rainy season all the rain falls in about 200 hours and half of it in 30 – 40 hours.
- Consequently runoff is very high. If it is captured and stored, it can be used effectively later on..

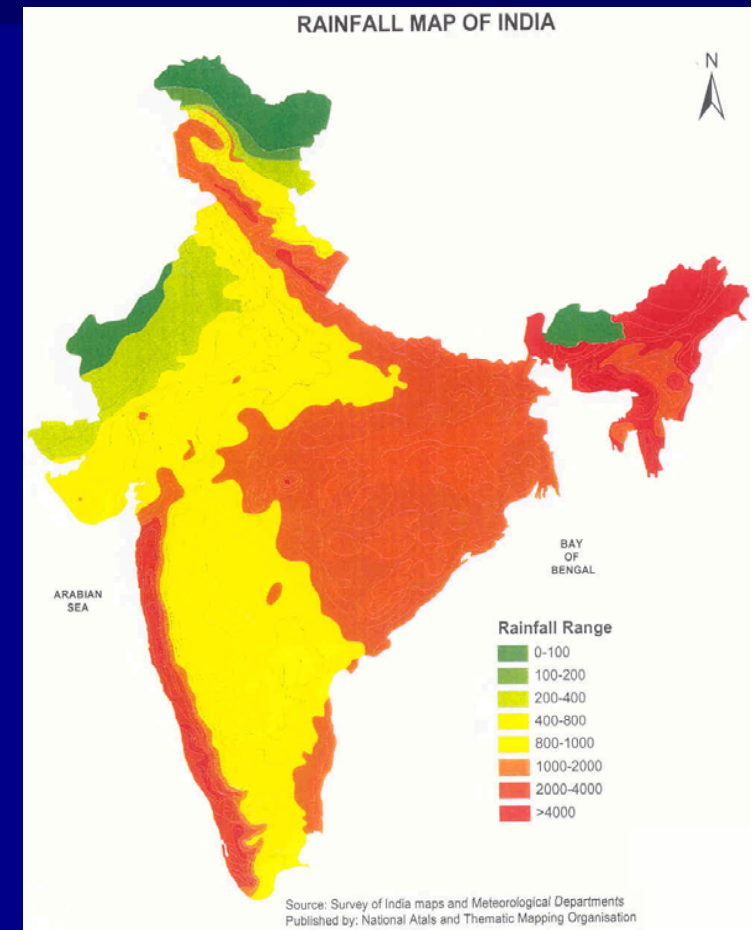

WATERSHED MANAGEMENT

Rainfall in Mumbai

- Average total annual rainfall is 2335 mm.
 - Average annual temperature is 27.2oC
- Based on 25 years data (1982-2006).

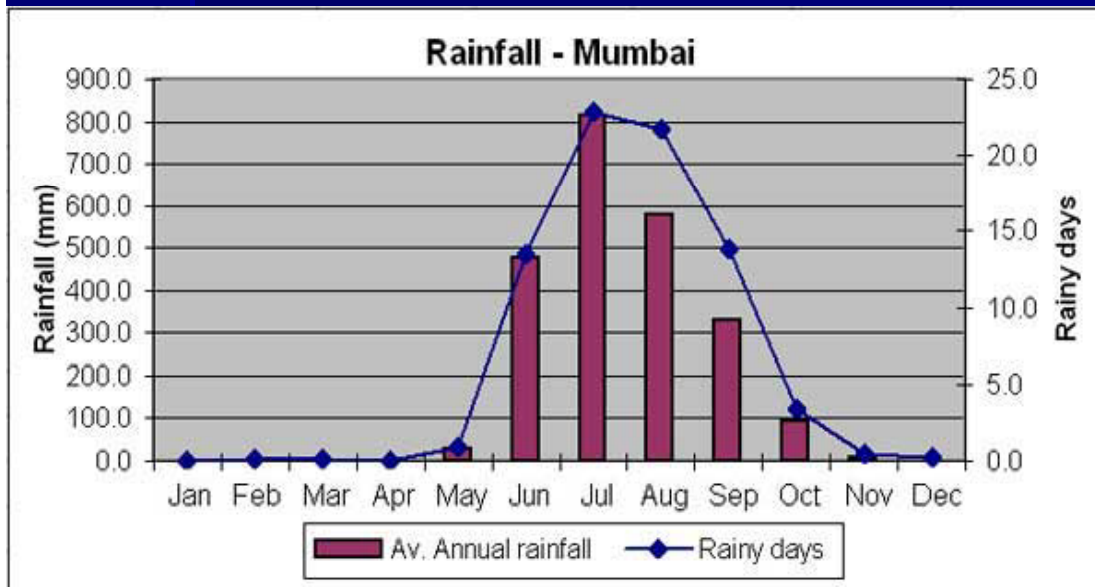

Months	Av. Annual Rainfall (mm)	Rainy Days
Jan	1.0	0.0
Feb	0.5	0.1
Mar	0.7	0.1
Apr	0.4	0.0
May	29.6	1.0
Jun	475.1	13.5
Jul	815.9	22.8
Aug	579.3	21.7
Sep	328.4	13.8
Oct	93.7	3.4
Nov	8.2	0.4
Dec	1.9	0.3
Total	2334.6	77.2

Hydro-geological Aspects of RWH

- Hydrogeology of the area -nature & extent of aquifer, soil cover, topography, depth to water levels & chemical quality of ground water.
- Eg. Geology of India is as diverse as its geography and people. It contains rocks covering almost the entire spectrum of the Geological Time Scale.
- Eg: Archean, Deccan Trap, Gondwana Super group, Vindhyan Super group , The Tertiary group etc.

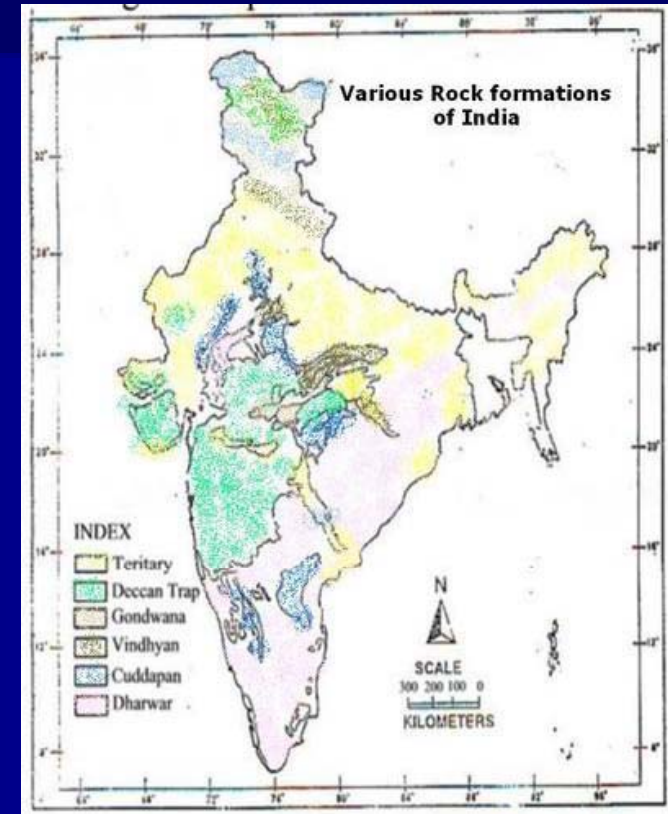

<http://cgwb.gov.in>

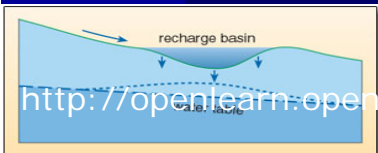

Hydro-geology & Water Resources

- Water resources- as a result of Hydrogeology – **Important parameters**
- soil thickness
- distribution of rock exposures
- pore networks in the rocks
- water recharge areas, discharge locations, and general flow directions of groundwater
- fluid-flow characteristics of main aquifer types, including yield
- ground features (eg. lineament)

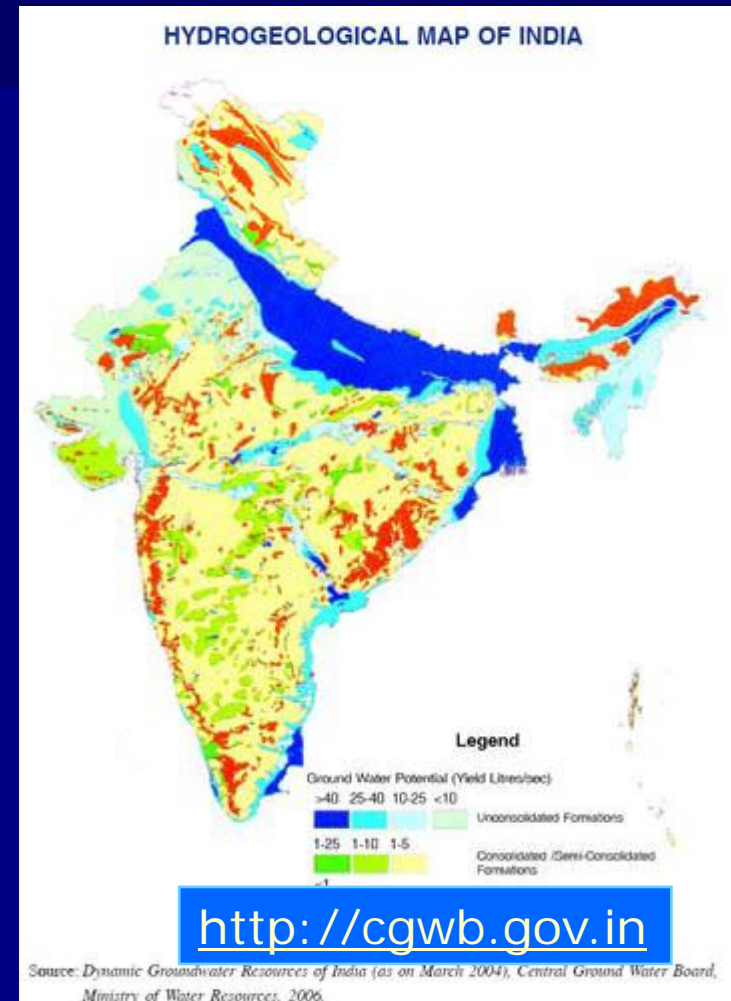

WATERSHED MANAGEMENT

Groundwater & Recharge

- **Groundwater** - major sources for water supply in many parts of the world.
- Ground water collects in aquifers over thousands of years through infiltration & ground water flow recharge.
- A particular amount of groundwater is replenished regularly through rainwater infiltration.
- Sustainable use of groundwater means withdrawal of ground water at a rate at which it is replenished through recharge.
- Faster withdrawal rates would lead to fall in water table & finally depletion of ground water.
- The ground water recharge areas need to be identified so that max. recharge can be achieved.

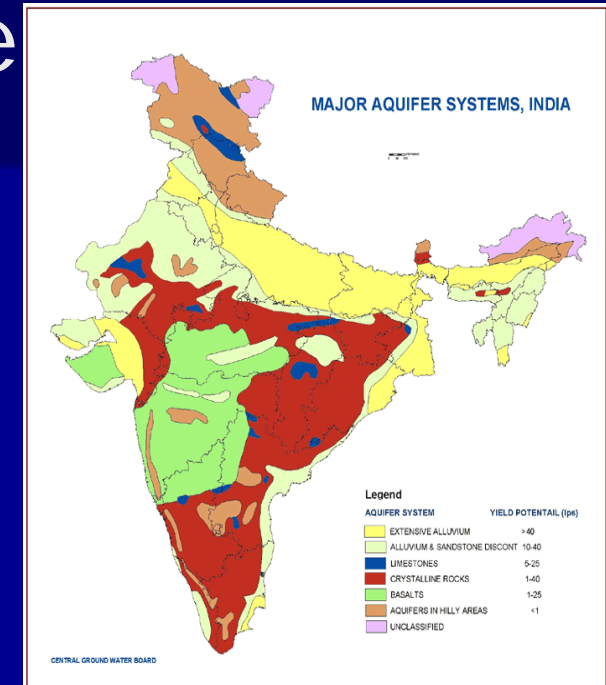

<http://cgwb.gov.in>

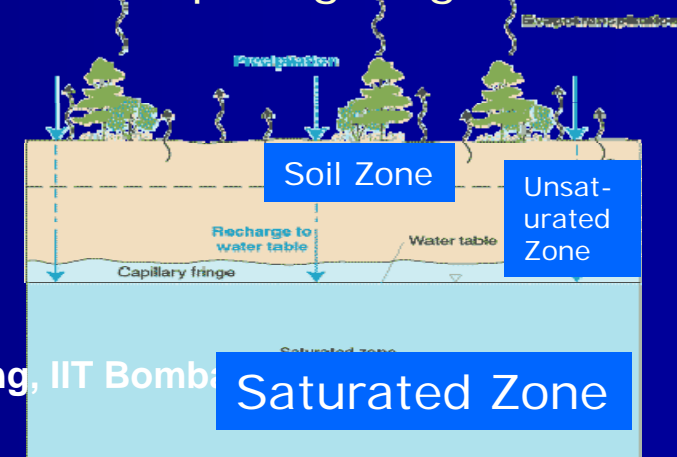

Prof. T I Eldho, Department of Civil Engineering, IIT Bombay

Saturated Zone

Groundwater Recharge

- Groundwater availability depends on recharge.
- Groundwater - controlled by the hydro-geological situation characterized by alluvial formation & quartzitic hard rocks.
- Groundwater quantity depends- Potential Areas & availability of unsaturated zone for recharge.
- Pre-requisites for artificial recharge:
 - 1. Favorable hydrological set-up.
 - 2. Developed aquifers.
 - 3. Availability of unpolluted surface water.
 - 4. Ground water dependent community.
- **Natural Recharge**
 - ✓ Naturally occurring water added to an aquifer
 - ✓ Natural recharge comes from precipitation or storm runoff
- **Artificial Recharge**
 - ✓ Store surplus surface water underground
 - ✓ Putting surface water in basins, furrows, ditches, or other facilities

Prof. T I Eldho, Department of Civil Engineering, IIT Bombay

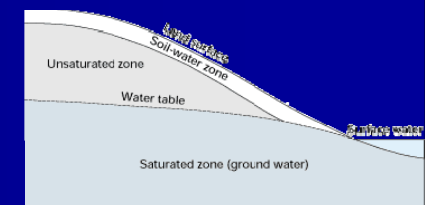

Artificial Recharge Techniques

□ **Direct surface techniques**

- Flooding
- Basins or percolation tanks
- Stream augmentation
- Ditch and furrow system
- Over irrigation

□ **Direct sub surface techniques**

- Injection wells or recharge wells
- Recharge pits and shafts
- Dug well recharge
- Bore hole flooding
- Natural openings, cavity fillings.

□ **Combination surface – sub-surface techniques**

- Basin or percolation tanks with pit shaft or wells.
- **Indirect Techniques**
 - Induced recharge from surface water source.
 - Aquifer modification.



Rainwater Harvesting Structures

- Storage of rain water on surface for future use
- Recharge to groundwater
- Pits
- Trenches
- Dug wells
- Hand pumps
- Recharge wells
- Recharge shafts
- Lateral shafts with bore wells
- Spreading techniques

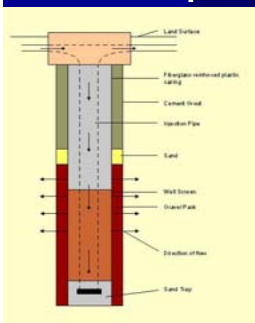
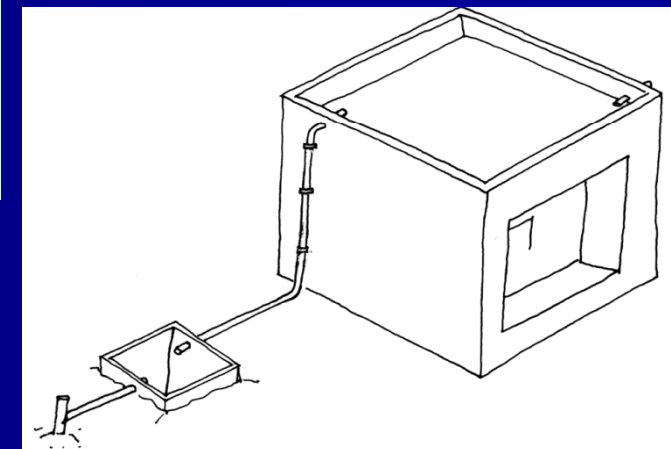
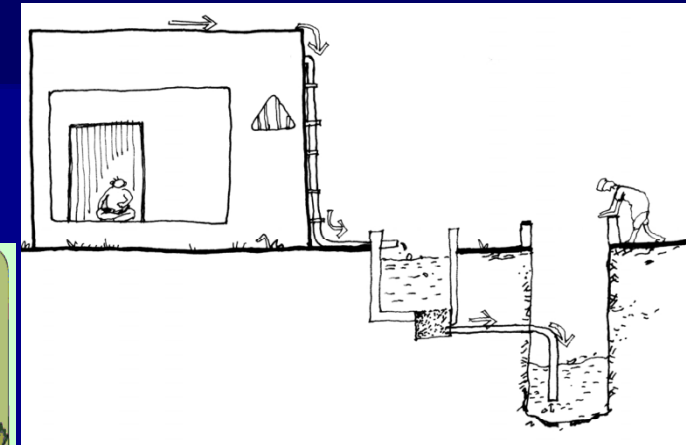
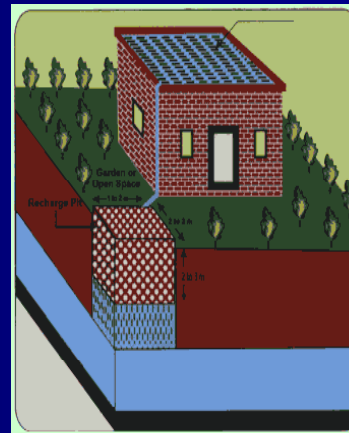

(Source: <http://rainwaterharvesting.org>)

Recharge

- ✓ Soil water balance method

$$R_i = P - E_a + \Delta W - R_o$$

Where,

R_i = recharge
 P = precipitation
 E_a = actual evapotranspiration
 ΔW = change in soil water storage

R_o = run-off

- ✓ Ground water level fluctuation method

$$R_i = S_y \cdot \Delta s + T_p - R_r$$

where,

S_y = specific yield
 T_p = the abstraction during the rainy seasons divided by the study area, and
 R_r = the return flow due to any irrigation which occurs during the rainy season

- ✓ Ground water balance method

In general,

$$I - O = \Delta W / \Delta t$$

where,

I = inflow (m^3/day) during time Δt
 O = outflow (m^3/day) during time Δt
 W = change in water volume (m^3)

Design Considerations of RWH

- Requirement – Direct use – Storage & needs
- Recharge to improve groundwater availability
- Hydrogeology of the area - nature & extent of aquifer, soil cover, topography, depth to water levels & chemical quality of ground water
- Area contributing for runoff i.e. how much area & land use pattern, whether industrial, residential or green belts and general built up pattern of the area
- Hydro-meteorological characters viz. rainfall duration, general pattern & intensity of rainfall
 - Recharge structures should be designed based on availability of space, availability of runoff, depth to water table & lithology of the area.
- Runoff should be accurately estimated.



Photo, A.K. Singh, 2002

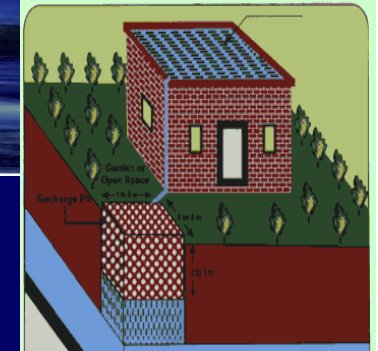

Integrated RWH Methodology

(Source: <http://rainwaterharvesting.org>)

- Based on: Geology, Topography, demand, water availability, infiltration rate, economic status of the users.
- Integrated Rainwater harvesting system designed
- Combination of Rainwater Harvesting structures like recharge trenches, sump, percolation pond etc.
- Rainwater harvesting in the study area may be divided into two
 - (i) from built up areas
 - (ii) from non-built up areas
 - (iii) watershed based approach.



Photo, A.K. Singh, 2002

Prof. T I Eldho, Department of Civil Engineering, IIT



WATERSHED MANAGEMENT

Flowchart for Integrated RWH in an Area

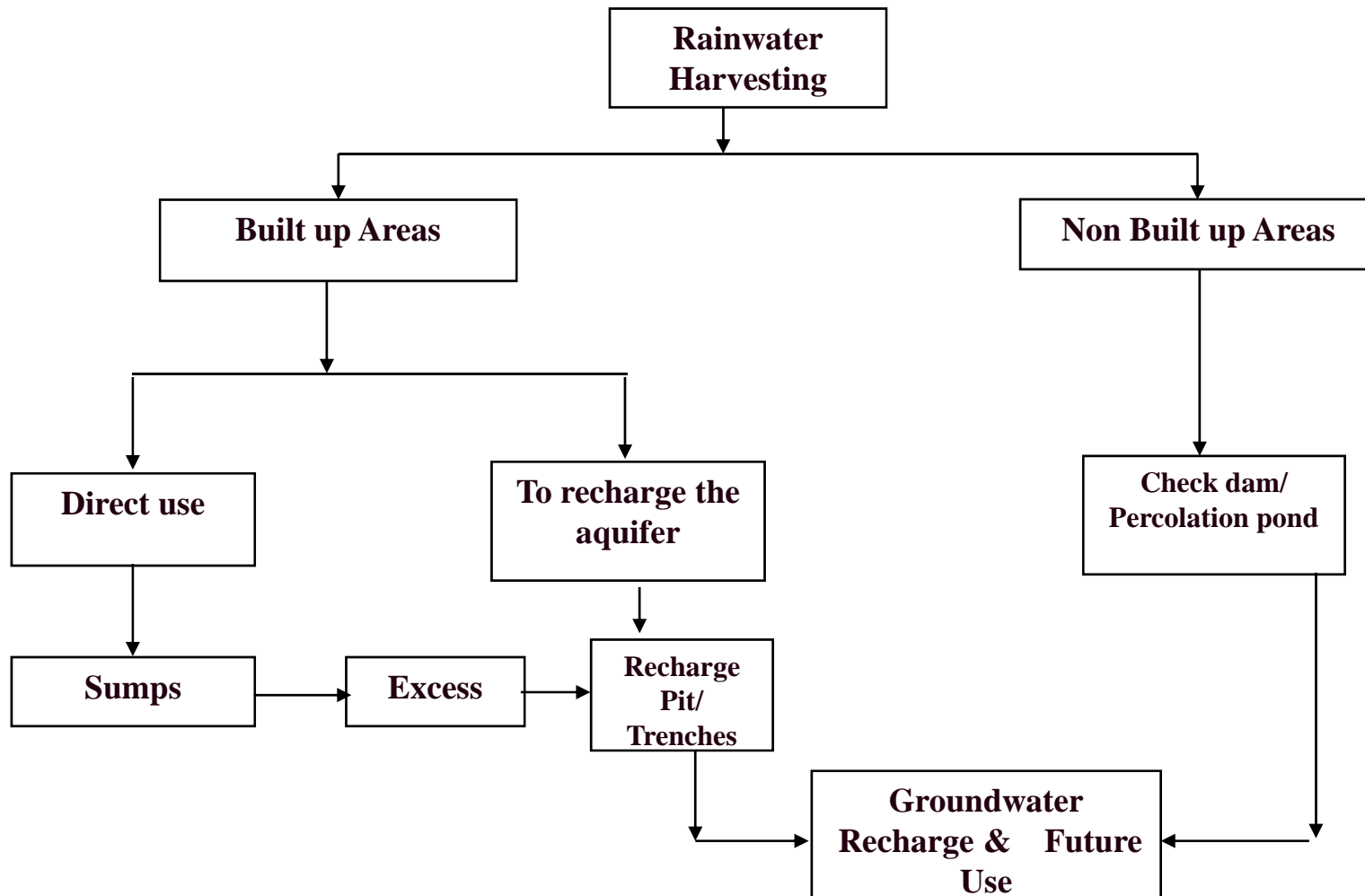

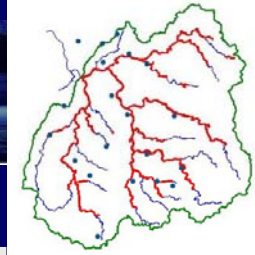

Case Study: RWH in Jhabua Watershed

- Madhya Pradesh (INDIA), ~ altitude of 380 m to 540 m. Area – 1800 sq.km
- Highly undulating, sparsely distributed forest cover.
- 57% arable land including cultivable fallow & 18% notified as forest land.
- Average rainfall ~ 750 mm per annum.
- 20-30 events during June-September
- Classified as drought prone region.
- Moisture deficit during January to May months each year.

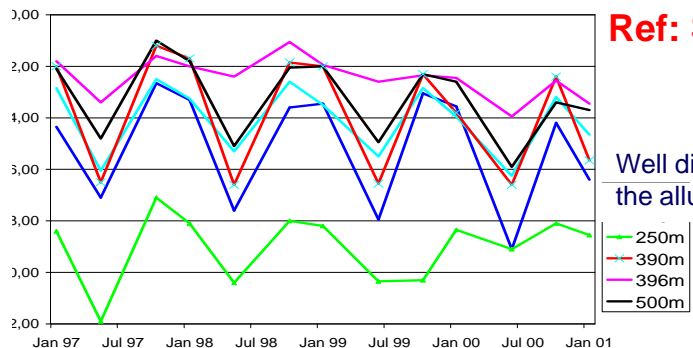
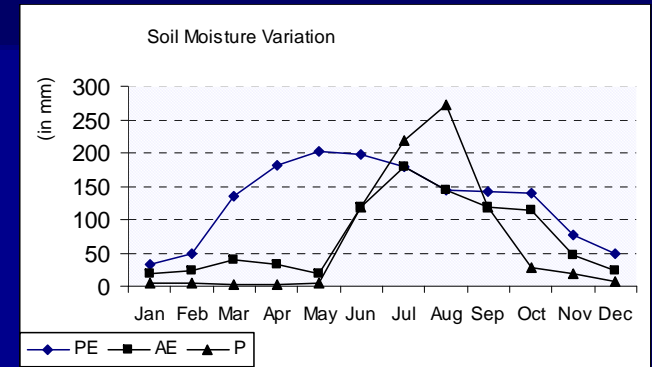

Ref: Singh, A.K., T.I. Eldho, D. Prinz (2002)

Well distance from the alluvium

— 250m
— 390m
— 396m
— 500m

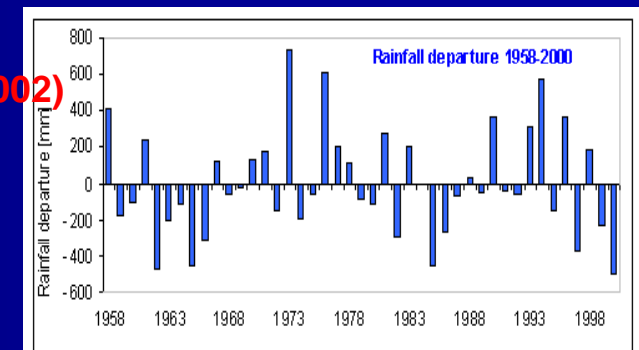

Case Study: RWH in Jhabua Watershed

- RWH Measures - Total number of reservoirs = 144
- Storage capacity = 81.3×10^6 m³
- Water conservation and groundwater recharge techniques
- Water harvesting cum supplementary irrigation techniques
- Rainwater harvesting interventions includes contour trenches, gully plugging, vegetative and field bunding, check dams, percolation tanks etc.

Reservoir in main channel

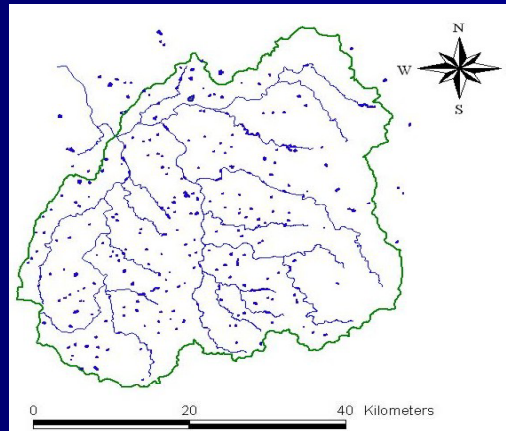
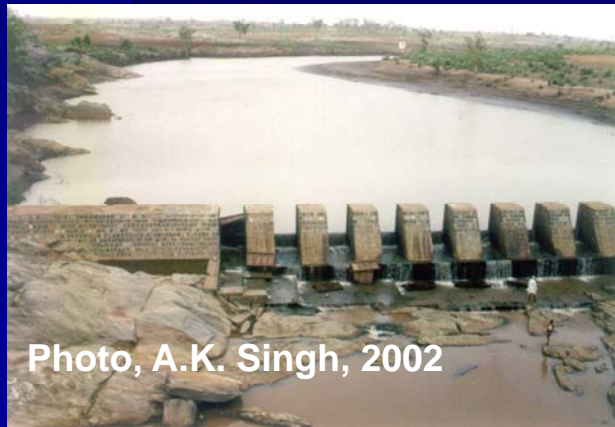

Case Study: RWH - Impacts

- About 2-4 meter water level increase is observed in selected wells.
- Sufficient water for domestic and agricultural purposes
- One farming per year 2 to 3 farming of various crops
- No water scarcity even in drought period.
- Agricultural yield increased by 30-60%
- Improvement in % of forest land
- Overall economic & social upliftment of the people
- People participation in the RWH schemes.



Photo, A.K. Singh, 2002

Prof. T I Eldho, Department of Civil Engineering, IIT Bombay



Photo, A.K. Singh, 2002

References

- CGWB, <http://cgwb.gov.in/groundwater>
- J.V.S Murthy (1991), Watershed Management, New Age international Publications
- Ghanshyam Das (2000), Hydrology and soil conservation engineering, Prentice Hall of India
- Patel and Shah (2008), Water Management, New Age international Publications
- www.rainwaterharvesting.org
- www.cseindia.org
- www.fao.org
- <http://forest.mtu.edu/>

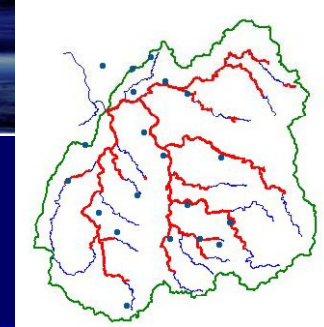

Tutorials - Question!..?.

- **Describe the traditional water harvesting system adopted in India.**
- (Ref: <http://cgwb.gov.in>; www.rainwaterharvesting.org; www.cseindia.org)
- Illustrate the systems used for roof rain water harvesting.
- Illustrate the various schemes used for Groundwater recharge schemes
- Discuss various techniques adopted at various locations.
- Discuss the merits and demerits of each systems.

Prof. T I Eldho, Department of Civil Engineering, IIT Bombay

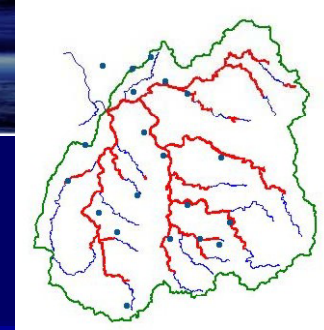

Self Evaluation - Questions!.

- Discuss the necessity & purposes of RWH.
- What are the advantages of RWH?.
- Discuss the hydrological aspects of RWH.
- Illustrate the importance of hydro-geological aspects of RWH.
- What are the important design considerations of RWH?.

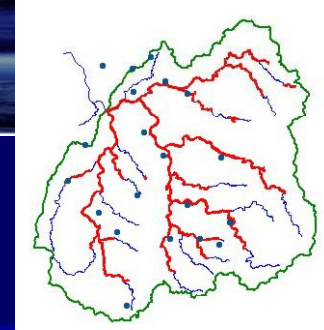

Assignment- Questions?.

- Illustrate various RWH methodologies for various locations.
- How to assess RWH potential for an area?.
- Discuss various techniques of artificial groundwater recharge.
- What is integrated RWH methodology?.

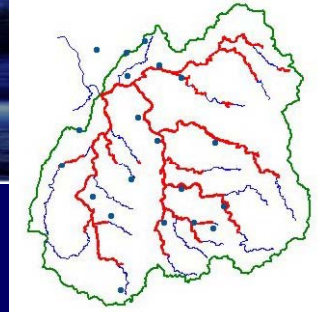

Unsolved Problem!.

- For your Watershed area, prepare an integrated plan of Rainwater Harvesting Scheme considering water storage & recharge.
- Identify the present supply & demand of water.
- Identify built-up area, non-built-up area
- Check the possibility of direct RWH in tanks & recharge.
 - Collect data – rainfall, soil data etc.
 - Design an integrated RWH scheme including groundwater recharge.

WATERSHED MANAGEMENT

THANK YOU

Dr. T. I. Eldho

Professor,

Department of Civil Engineering,
Indian Institute of Technology Bombay,
Mumbai, India, 400 076.

Email: eldho@iitb.ac.in

Phone: (022) – 25767339; Fax: 25767302

<http://www.civil.iitb.ac.in>

